

**1/4" Dr. Extension Bars**

Chrome Vanadium steel,  
Matt finish, Bulk

Nr. 514 050EX	50mm
Nr. 514 100EX	100mm
Nr. 514 150EX	150mm

**1/4" Dr. Flexible Extension Bar**

Chrome Vanadium steel,  
Matt finish, Bulk

Nr. 514 1150F	150mm
---------------	-------

**1/4" Dr. Sliding T-Bar**

Chrome Vanadium steel,  
Matt finish, Bulk

Nr. 514 1420ST	110mm
----------------	-------

**1/4" Dr. Spinner Handle**

Chrome Vanadium steel,  
Matt finish, Bulk

Nr. 514 2150	150mm
--------------	-------

**1/4" Dr. Adaptor**

Chrome Vanadium steel,  
Matt finish, Bulk

Nr. 514 AD1438	1/4"(F) x 3/8"(M)
----------------	-------------------

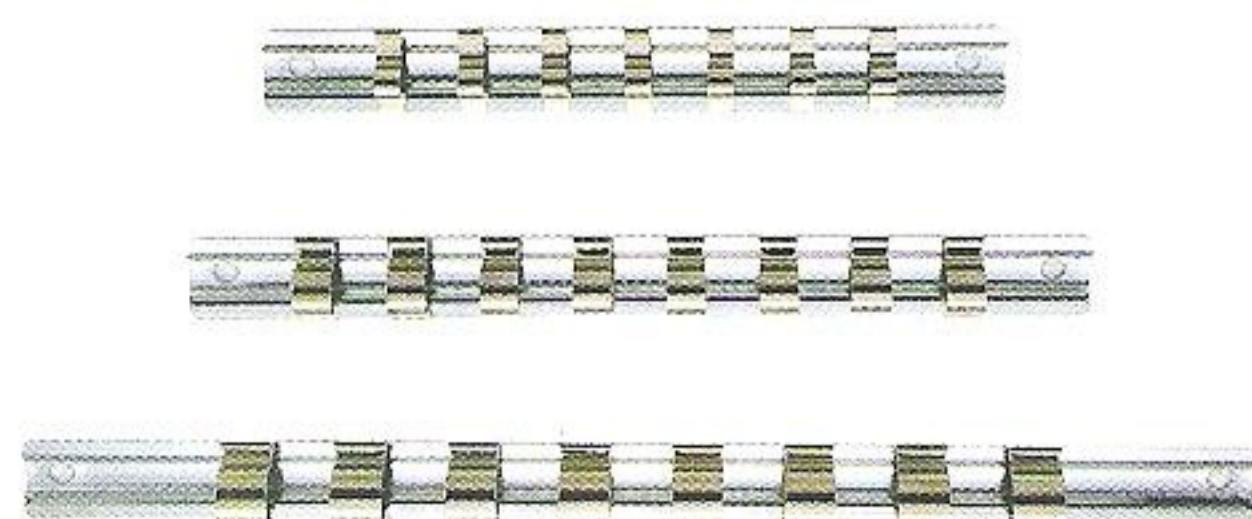
**Metal Socket Holder**

Pressed sheet metal, Chrome plated  
With clips, Bulk

Nr. 514 9160	1/4" x 160mm x 7 clips
Nr. 538 9400	3/8" x 400mm x 14 clips
Nr. 512 9400	1/2" x 400mm x 14 clips

### 1/4" Dr. Deep E-TX Sockets

Chrome Vanadium steel, with knurling  
Half polished, Half matt, Bulk

Nr. 514 D140E4	E4
Nr. 514 D140E5	E5
Nr. 514 D140E6	E6
Nr. 514 D140E7	E7
Nr. 514 D140E8	E8
Nr. 514 D140E10	E10



### 1/4" Dr. Superlock, Sockets

Chrome Vanadium steel, with knurling  
Matt finish, Bulk

Nr. 514 1404	4mm	Nr. 514 1409	9mm
Nr. 514 14045	4.5mm	Nr. 514 1410	10mm
Nr. 514 1405	5mm	Nr. 514 1411	11mm
Nr. 514 1406	6mm	Nr. 514 1412	12mm
Nr. 514 1407	7mm	Nr. 514 1413	13mm
Nr. 514 1408	8mm	Nr. 514 1414	14mm



### 1/4" Dr. Superlock Deep Sockets

Chrome Vanadium steel, with knurling  
Matt finish, Bulk

Nr. 514 1406D	6mm
Nr. 514 1407D	7mm
Nr. 514 1408D	8mm
Nr. 514 1409D	9mm
Nr. 514 1410D	10mm
Nr. 514 1411D	11mm
Nr. 514 1412D	12mm
Nr. 514 1413D	13mm



### 1/4" FLANK Dr. 6PT Sockets

Chrome Vanadium steel, without knurling  
Matt finish, Bulk

Nr. 514 1404F	4mm	Nr. 514 1409F	9mm
Nr. 514 14045F	4.5mm	Nr. 514 1410F	10mm
Nr. 514 1405F	5mm	Nr. 514 1411F	11mm
Nr. 514 1406F	6mm	Nr. 514 1412F	12mm
Nr. 514 1407F	7mm	Nr. 514 1413F	13mm
Nr. 514 1408F	8mm	Nr. 514 1414F	14mm



### 1/4" FLANK Dr. 6PT Deep Socket

Chrome Vanadium steel, with knurling,  
Half polished, Half matt, Bulk

Nr. 514 1406DF	6mm	Nr. 514 1410DF	10mm
Nr. 514 1407DF	7mm	Nr. 514 1411DF	11mm
Nr. 514 1408DF	8mm	Nr. 514 1412DF	12mm
Nr. 514 1409DF	9mm	Nr. 514 1413DF	13mm





**1/4" Dr. Slotted bit Sockets (32mm)**  
 Chrome Vanadium steel, w/o knurling,  
 Matt finish, Bulk

Nr. 514 1704 S	4mm
Nr. 514 17055 S	5.5mm
Nr. 514 17065 S	6.5mm
Nr. 514 1707 S	7mm



**1/4" Dr. Phillip Bit Sockets (32mm)**  
 Chrome Vanadium steel, w/o knurling,  
 Matt finish, Bulk

Nr. 514 1800	PH#0
Nr. 514 1801	PH#1
Nr. 514 1802	PH#2
Nr. 514 1803	PH#3



**1/4" Dr. POZI Bit Sockets (32mm)**  
 Chrome Vanadium steel, w/o knurling,  
 Matt finish, Bulk

Nr. 514 1900PZ	PZ#0
Nr. 514 1901PZ	PZ#1
Nr. 514 1902PZ	PZ#2
Nr. 514 1903PZ	PZ#3



**1/4" Dr. Hex. Bit Sockets (32mm)**  
 Chrome Vanadium steel, w/o knurling  
 Matt finish, Bulk

Nr. 514 1503H	H3
Nr. 514 1504H	H4
Nr. 514 1505H	H5
Nr. 514 1506H	H6
Nr. 514 1507H	H7
Nr. 514 1508H	H8



**1/4" Dr. TX Bit sockets (32mm)**  
 Chrome Vanadium steel, w/o knurling  
 Matt finish, Bulk

Nr. 514 1608T	T8
Nr. 514 1609T	T9
Nr. 514 1610T	T10
Nr. 514 1615T	T15
Nr. 514 1620T	T20
Nr. 514 1625T	T25
Nr. 514 1627T	T27
Nr. 514 1630T	T30
Nr. 514 1640T	T40

## 1/4" Dr. E-TX Socket

Chrome Vanadium steel, with knurling  
Half polished, Half matt, Bulk

Nr. 514 140E4	E4
Nr. 514 140E5	E5
Nr. 514 140E6	E6
Nr. 514 140E7	E7
Nr. 514 140E8	E8
Nr. 514 140E10	E10
Nr. 514 140E11	E11



## 1/4" Dr. Bit Adaptor Sockets

Chrome Vanadium steel,  
Matt finish, Bulk

Nr. 514 AD1414



## 1/4" Dr. Universal Joint

Chrome Vanadium steel,  
Matt finish, Bulk

Nr. 514 1414UJ  
Nr. 514 1424UJ (with spring)



514 1414UJ



514 1424UJ

## 1/4" Dr. 5-Points Bit Sockets, Insert Type

Chrome Vanadium steel, S2 Bit with hole,  
Matt finish, Bulk

Nr. 514 52ST10	T10	37mm
Nr. 514 52ST15	T15	37mm
Nr. 514 52ST20	T20	37mm
Nr. 514 52ST25	T25	37mm
Nr. 514 52ST27	T27	37mm
Nr. 514 52ST30	T30	37mm
Nr. 514 52ST40	T40	37mm



## 1/4" Dr. 5-Points Bit Sockets, One Piece Formed

Chrome Vanadium steel, Black tip with hole,  
Matt finish, Bulk

Nr. 514 51ST10	T10	25mm
Nr. 514 51ST15	T15	25mm
Nr. 514 51ST20	T20	25mm
Nr. 514 51ST25	T25	25mm
Nr. 514 51ST27	T27	25mm
Nr. 514 51ST30	T30	25mm
Nr. 514 51ST40	T40	25mm





Nr. 538 5012

**12-pcs 1/4" & 3/8" Dr. E-TX Socket Set**

Chrome Vanadium steel, with knurling,  
Matt finish, Packed on socket holder, Polybaged

Consisting of :

5 x 1/4" Dr. : E4 - E5 - E6 - E7 - E8

7 x 3/8" Dr. : E10 - E11 - E12 - E14 - E16 - E18 - E20

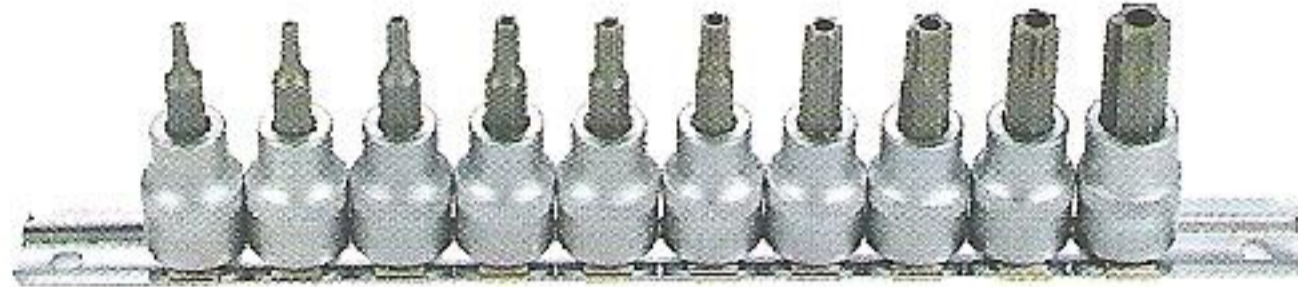

Nr. 538 4010

**10-pcs 3/8" Dr. Tamp. TX Bit Socket Set**

Chrome Vanadium steel, with knurling,  
Matt finish, Packed on socket holder, Polybaged

Consisting of : T10 - T15 - T20 - T25 - T27 - T30 - T40  
T45 - T50 - T55

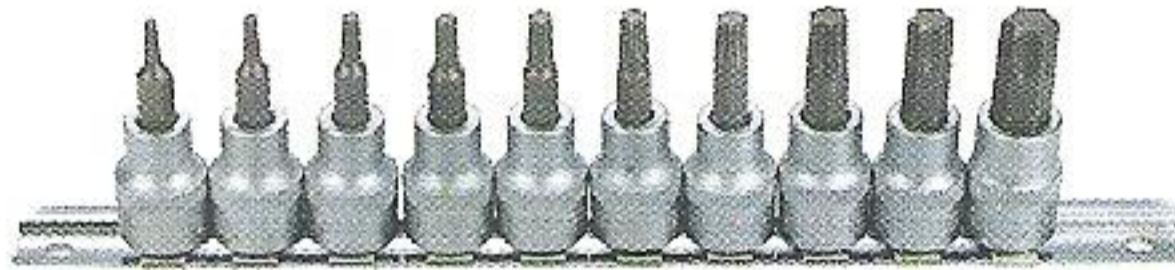

Nr. 538 5010

**10-pcs 3/8" Dr. TX Bit Socket Set**

Chrome Vanadium steel, with knurling,  
Matt finish, Packed on socket holder, Polybaged

Consisting of : T10 - T15 - T20 - T25 - T27 - T30 - T40  
T45 - T50 - T55

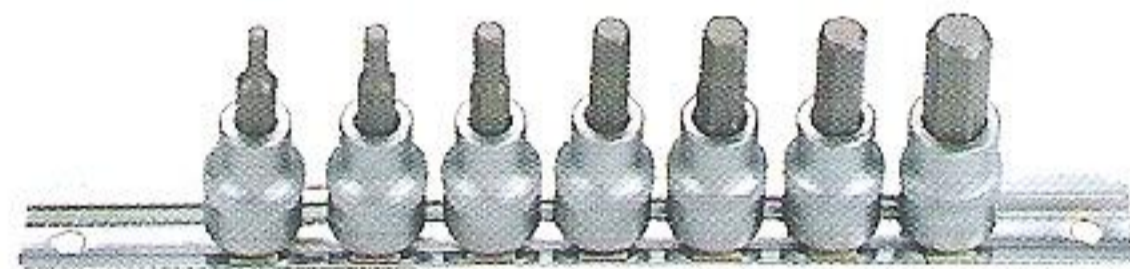

Nr. 538 4007

**7-pcs 3/8" Dr. Hex Bit Socket Set**

Chrome Vanadium steel, with knurling,  
Matt finish, Packed on socket holder, Polybaged

Consisting of : H3 - H4 - H5 - H6 - H7 - H8 - H10

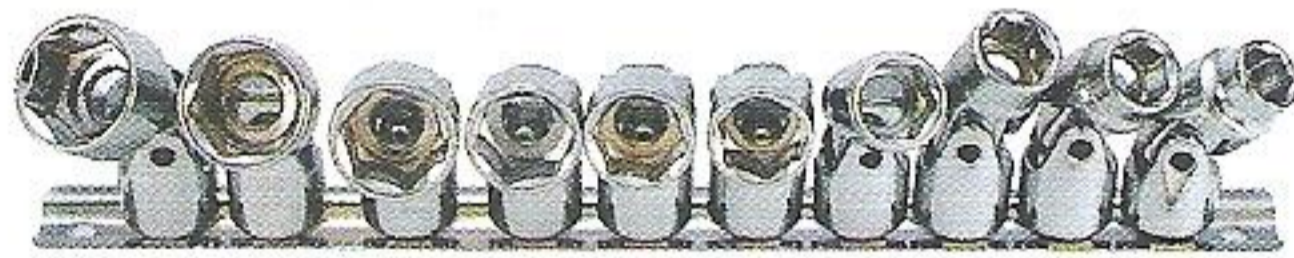

Nr. 538 8010

**10-pcs 3/8" Dr. Universal Socket Set**

Chrome Vanadium steel, Mirror polish  
Chrome plated, Packed on socket holder

Consisting of: 10 - 11 - 12 - 13 - 14 - 15  
16 - 17 - 18 - 19mm

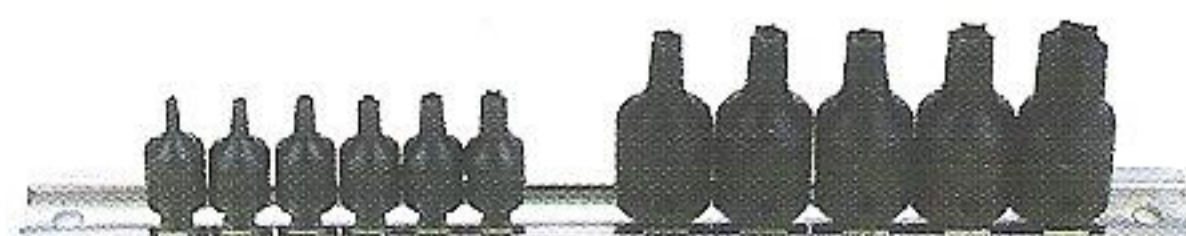

Nr. 538 9011

**11-pcs 1/4" & 3/8" Dr. TX Bit Socket Set**

Chrome Vanadium steel, One piece formed  
With hole, Black finish,  
Packed on socket holder

Consisting of:

6 x 1/4" Dr. T10 - T15 - T20 - T25 - T27 - T30

5 x 3/8" Dr. T40 - T45 - T50 - T55 - T60

### 3/8" Dr. Reversibel Ratchet Handles

Chrome Vanadium steel, Matt finish or Chrome Plated, Bulk.

Nr. 538 RH24A	24 Teeth	Chrome plated
Nr. 538 RH24B	24 Teeth	Matt finish
Nr. 538 RH45T	45 Teeth	Matt finish
Nr. 538 RH72A	72 Teeth	Matt finish
Nr. 538 RH72B	72 Teeth	Matt finish

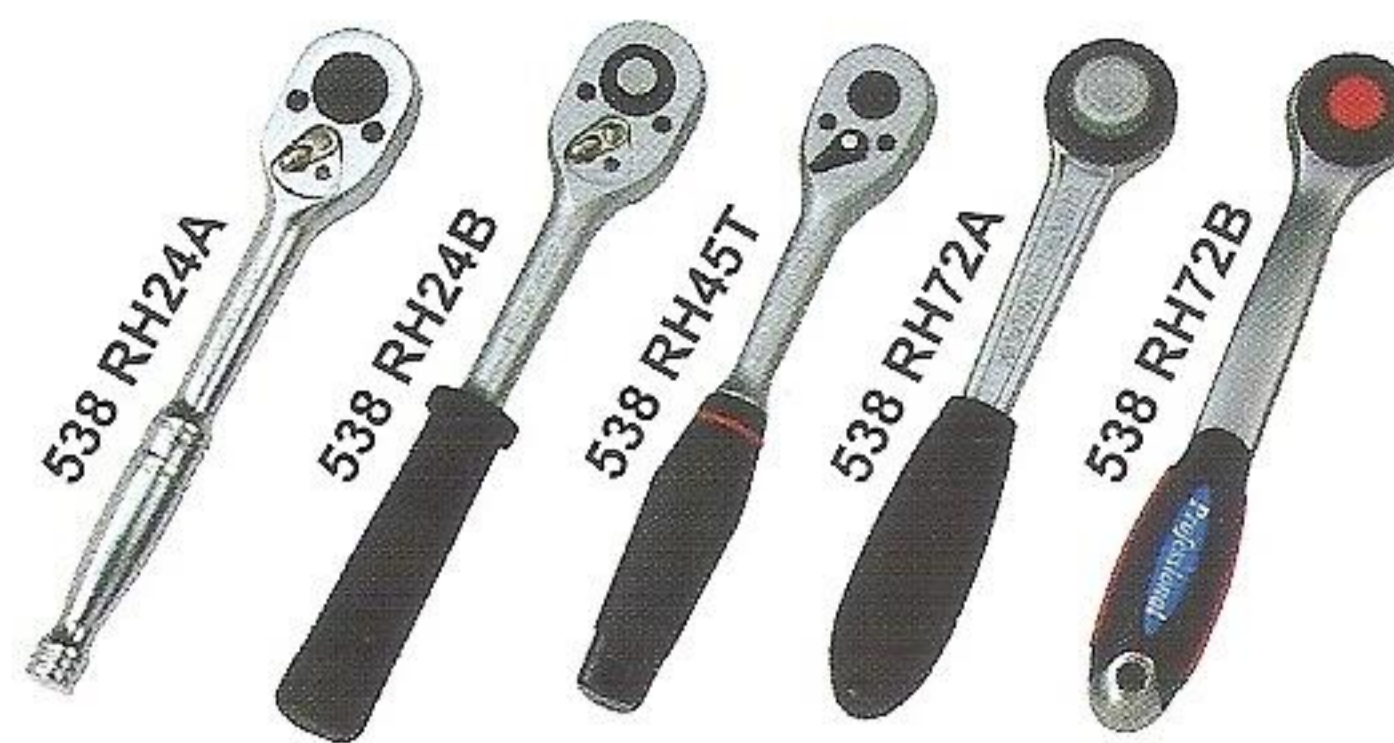

### 3/8" Dr. Superlock Sockets

Chrome Vanadium steel, with knurling Matt finish, Bulk

Nr. 538 3806	6mm	Nr. 538 3815	15mm
Nr. 538 3807	7mm	Nr. 538 3816	16mm
Nr. 538 3808	8mm	Nr. 538 3817	17mm
Nr. 538 3809	9mm	Nr. 538 3818	18mm
Nr. 538 3810	10mm	Nr. 538 3819	19mm
Nr. 538 3811	11mm	Nr. 538 3820	20mm
Nr. 538 3812	12mm	Nr. 538 3821	21mm
Nr. 538 3813	13mm	Nr. 538 3822	22mm
Nr. 538 3814	14mm	Nr. 538 3824	24mm



### 3/8" Dr. Superlock Deep Sockets

Chrome Vanadium steel, with knurling, Matt finish, Bulk

Nr. 538 3808D	8mm
Nr. 538 3809D	9mm
Nr. 538 3810D	10mm
Nr. 538 3811D	11mm
Nr. 538 3812D	12mm
Nr. 538 3813D	13mm
Nr. 538 3814D	14mm
Nr. 538 3815D	15mm
Nr. 538 3817D	17mm
Nr. 538 3819D	19mm



### 3/8" Dr. E-TX Sockets

Chrome Vanadium steel, with knurling, Half polished, Half matt, Bulk

Nr. 538 380E4	E4
Nr. 538 380E5	E5
Nr. 538 380E6	E6
Nr. 538 380E7	E7
Nr. 538 380E8	E8
Nr. 538 380E10	E10
Nr. 538 380E11	E11
Nr. 538 380E12	E12
Nr. 538 380E14	E14
Nr. 538 380E16	E16
Nr. 538 380E18	E18
Nr. 538 380E20	E20



### 3/8" Dr. Deep E-TX Sockets

Chrome Vanadium steel, with knurling, Half polished, Half matt, Bulk

Nr. 538 D380E8	E8
Nr. 538 D380E10	E10
Nr. 538 D380E11	E11
Nr. 538 D380E12	E12
Nr. 538 D380E14	E14
Nr. 538 D380E16	E16
Nr. 538 D380E18	E18



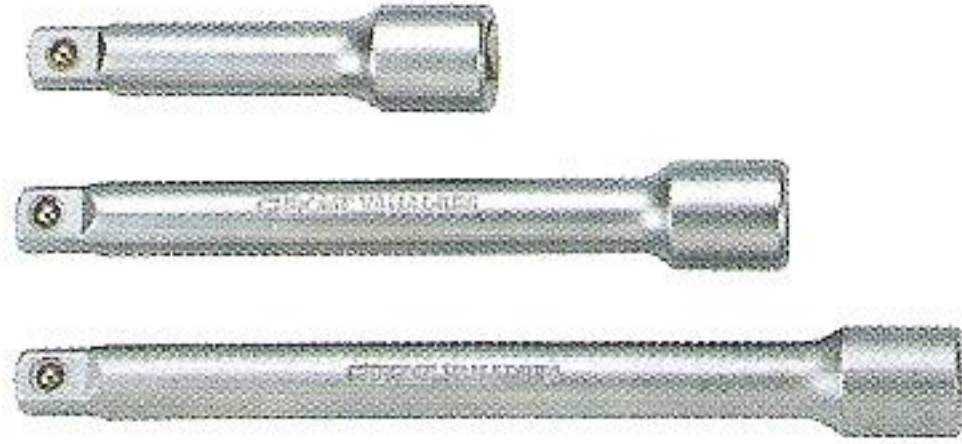

**3/8" Dr. Extension Bars**  
 Chrome Vanadium steel,  
 Matt finish, Bulk  
 Nr. 538 3075EX      75mm  
 Nr. 538 3150EX      150mm  
 Nr. 538 3200EX      200mm  
 Nr. 538 3250EX      250mm



**3/8" Dr. Flexible Extension Bar**  
 Chrome Vanadium steel,  
 Chrome plated, Bulk  
 Suitable for use where traditional  
 Extension bar will not reach.  
 Nr. 538 3200F      200mm



**3/8" Dr. Sliding T-Bar**  
 Chrome Vanadium steel  
 Matt finish, Bulk  
 Nr. 538 3160ST      160mm



**3/8" Dr. Spark Plug Sockets**  
 Chrome Vanadium steel,  
 Matt finish, Bulk  
 Nr. 538 5014      14mm  
 Nr. 538 5016      16mm  
 Nr. 538 5021      21mm  
 Nr. 538 5018      18mm



538 3838UJ

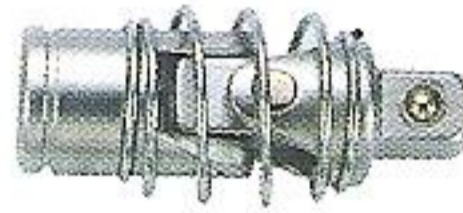

538 3828UJ

**3/8" Dr. Universal Joint**  
 Chrome Vanadium steel  
 Matt finish, Bulk  
 Nr. 538 3828UJ      (with spring)  
 Nr. 538 3838UJ



**3/8" Dr. Bit Adaptor Sockets**  
 Chrome Vanadium steel,  
 Matt finish, Bulk  
 Nr. 538 AD3065      3/8" x 1/4"  
 Nr. 538 AD3008      3/8" x 5/16"  
 Nr. 538 AD3010      3/8" x 10mm



**3/8" Dr. Adaptor**  
 Chrome Vanadium steel,  
 Matt finish, Bulk  
 Nr. 538 AD3814      3/8"(F) x 1/4"(M)  
 Nr. 538 AD3812      3/8"(F) x 1/2"(M)

### 3/8" Dr. T-M Head

Chrome Vanadium steel,  
Matt finish, Bulk

Nr. 538 TM3814	3/8" x 1/4"
Nr. 538 TM3812	3/8" x 1/2"



### 3/8" Dr. TX Tamperproofed Bit Sockets

Chrome Vanadium steel,  
With knurling, Matt finish, Bulk

Nr. 538 1510T	T10
Nr. 538 1515T	T15
Nr. 538 1520T	T20
Nr. 538 1525T	T25
Nr. 538 1527T	T27
Nr. 538 1530T	T30
Nr. 538 1540T	T40
Nr. 538 1545T	T45
Nr. 538 1550T	T50
Nr. 538 1555T	T55



### 3/8" Dr. Slotted Bit Sockets

Chrome Vanadium steel, with knurling,  
Matt finish, Bulk

Nr. 538 17055S	5.5mm
Nr. 538 1707S	7mm
Nr. 538 1708S	8mm



### 3/8" Dr. Phillip Bit Sockets

Chrome Vanadium steel, with knurling,  
Matt finish, Bulk

Nr. 538 1800PH	PH#0
Nr. 538 1801PH	PH#1
Nr. 538 1802PH	PH#2
Nr. 538 1803PH	PH#3



### 3/8" Dr. POZI Bit Sockets

Chrome Vanadium steel, with knurling,  
Matt finish, Bulk

Nr. 538 1900PZ	PZ#0
Nr. 538 1901PZ	PZ#1
Nr. 538 1902PZ	PZ#2
Nr. 538 1903PZ	PZ#3



### 3/8" Dr. Hex. Bit Sockets

Chrome Vanadium steel, with knurling,  
Matt finish, Bulk

Nr. 538 1503H	H3
Nr. 538 1504H	H4
Nr. 538 1505H	H5
Nr. 538 1506H	H6
Nr. 538 1507H	H7
Nr. 538 1508H	H8
Nr. 538 1510H	H10





Nr. 540 5006R

**6-pcs 1/2" Dr. Spline Bit Socket Set (100mm)**  
 Chrome Vanadium steel, with knurling,  
 Matt finish, Packed on socket holder, Polybaged

Consisting of: M5 - M6 - M7 - M8 - M10 - M12

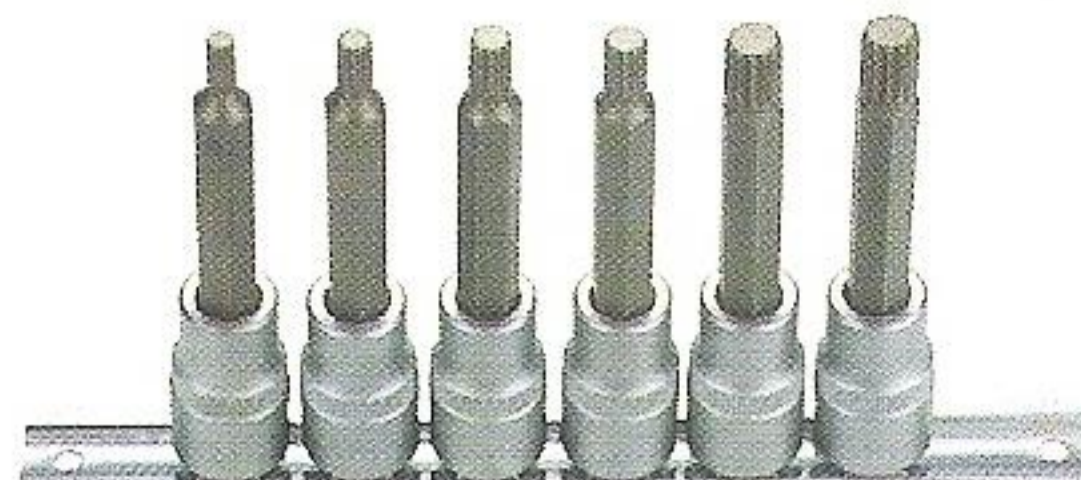

Nr. 540 5106R

**6-pcs 1/2" Dr. Ball Point Bit Socket Set (100mm)**  
 Chrome Vanadium steel, with knurling,  
 Matt finish, Packed on socket holder, Polybaged

Consisting of: 4 - 5 - 6 - 7 - 8 - 10mm



Nr. 540 5209R

**9-pcs 1/2" Dr. TX Bit Socket Set (100mm)**  
 Chrome Vanadium steel, with knurling,  
 Matt finish, Packed on socket holder, Polybaged

Consisting of: T20 - T25 - T27 - T30 - T40  
 T45 - T50 - T55 - T60

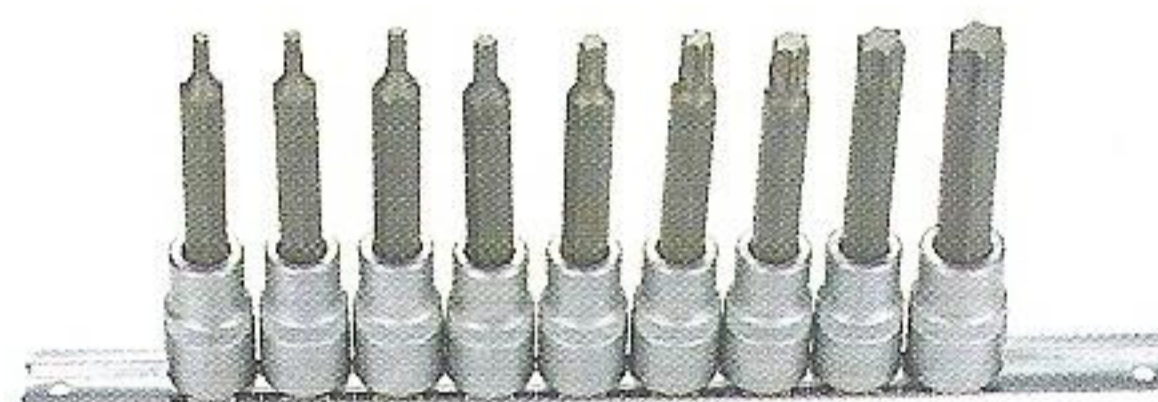

Nr. 691 1006

**6-pcs Adaptor Set**  
 Chrome Vanadium steel,  
 Matt finish, Packed in BMC

Consisting of:

1/4"(F) x 3/8"(M)	1/2"(F) x 3/8"(M)
3/8"(F) x 1/4"(M)	1/2"(F) x 3/4"(M)
3/8"(F) x 1/2"(M)	3/4"(F) x 1/2"(M)



Nr. 516 3003

**3-pcs 1/2" Dr. Deep Wall Colored Socket Set**  
 Chrome Vanadium steel, white plastic covering,  
 Packed in BMC

Consisting of:

17mm	Blue
19mm	Gold
21mm	Red



**1/2" Dr. Reversibel Ratchet Handles,**  
 Chrome Vanadium steel, Matt finish or  
 Chrome plated, Bulk

Nr. 512 RH24A	24 Teeth	Chrome plated
Nr. 512 RH24B	24 Teeth	Matt finish
Nr. 512 RH45T	45 Teeth	Matt finish
Nr. 512 RH72A	72 Teeth	Matt finish
Nr. 512 RH72B	72 Teeth	Matt finish



**1/2" Dr. Superlock Sockets**

Chrome Vanadium steel, with knurling,  
Matt finish, Bulk



Nr. 512 1208	8mm	Nr. 512 1219	19mm
Nr. 512 1209	9mm	Nr. 512 1220	20mm
Nr. 512 1210	10mm	Nr. 512 1221	21mm
Nr. 512 1211	11mm	Nr. 512 1222	22mm
Nr. 512 1212	12mm	Nr. 512 1223	23mm
Nr. 512 1213	13mm	Nr. 512 1224	24mm
Nr. 512 1214	14mm	Nr. 512 1226	26mm
Nr. 512 1215	15mm	Nr. 512 1227	27mm
Nr. 512 1216	16mm	Nr. 512 1228	28mm
Nr. 512 1217	17mm	Nr. 512 1230	30mm
Nr. 512 1218	18mm	Nr. 512 1232	32mm

**1/2" Dr. Superlock Deep Sockets**

Chrome Vanadium steel, with knurling  
Matt finish, Bulk



Nr. 512 1210D	10mm	Nr. 512 1218D	18mm
Nr. 512 1211D	11mm	Nr. 512 1219D	19mm
Nr. 512 1212D	12mm	Nr. 512 1220D	20mm
Nr. 512 1213D	13mm	Nr. 512 1221D	21mm
Nr. 512 1214D	14mm	Nr. 512 1222D	22mm
Nr. 512 1215D	15mm	Nr. 512 1223D	23mm
Nr. 512 1216D	16mm	Nr. 512 1224D	24mm
Nr. 512 1217D	17mm		

**1/2" FLANK Dr. 6 Point Sockets**

Chrome Vanadium steel, with blue strip printing.  
Half polished Half matt, Bulk



Nr. 512 2208	8mm	Nr. 512 2219	19mm
Nr. 512 2209	9mm	Nr. 512 2220	20mm
Nr. 512 2210	10mm	Nr. 512 2221	21mm
Nr. 512 2211	11mm	Nr. 512 2222	22mm
Nr. 512 2212	12mm	Nr. 512 2223	23mm
Nr. 512 2213	13mm	Nr. 512 2224	24mm
Nr. 512 2214	14mm	Nr. 512 2226	26mm
Nr. 512 2215	15mm	Nr. 512 2227	27mm
Nr. 512 2216	16mm	Nr. 512 2228	28mm
Nr. 512 2217	17mm	Nr. 512 2230	30mm
Nr. 512 2218	18mm	Nr. 512 2232	32mm

(Also available in 12 points)

**1/2" FLANK Dr. 6 Point Deep Sockets**

Chrome Vanadium steel, without knurling  
Chrome Plated, Bulk



Nr. 512 1210DF	10mm	Nr. 512 1218DF	18mm
Nr. 512 1211DF	11mm	Nr. 512 1219DF	19mm
Nr. 512 1212DF	12mm	Nr. 512 1220DF	20mm
Nr. 512 1213DF	13mm	Nr. 512 1221DF	21mm
Nr. 512 1214DF	14mm	Nr. 512 1222DF	22mm
Nr. 512 1215DF	15mm	Nr. 512 1223DF	23mm
Nr. 512 1216DF	16mm	Nr. 512 1224DF	24mm
Nr. 512 1217DF	17mm		

## 1/2" Dr. One Piece Formed TX Bit Sockets

Chrome Vanadium steel

Matt finish, Bulk

Nr. 512 L4440T	T40 x 125mm
Nr. 512 L4445T	T45 x 125mm
Nr. 512 L4450T	T50 x 125mm
Nr. 512 L4455T	T55 x 125mm
Nr. 512 L4460T	T60 x 125mm



## 1/2" Dr. One Piece Formed Spline Bit

Chrome Vanadium steel

Matt finish, Bulk

Nr. 512 L4410M	M10 x 125mm
Nr. 512 L4412M	M12 x 125mm
Nr. 512 L4414M	M14 x 125mm
Nr. 512 L4416M	M16 x 125mm



## 1/2" Dr. One Piece Formed Hex. Bit Sockets

Chrome Vanadium steel

Matt finish, Bulk

Nr. 512 L4408H	H8 x 125mm
Nr. 512 L4410H	H10 x 125mm
Nr. 512 L4412H	H12 x 125mm
Nr. 512 L4414H	H14 x 125mm



## 1/2" Dr. E-TX Extension Bar

Chrome Vanadium steel,

Matt finish, Bulk

Nr. 512 8012E	1/2" Dr. E12 x 150mm
Nr. 512 8014E	1/2" Dr. E14 x 150mm



## Universal Flexible Handle, 1/2" Dr.

Chrome Vanadium steel, matt finish

length of 375mm, Bulk

Nr. 512 9375	1/2" x 375mm
--------------	--------------



**1/2" Dr. E-TX Sockets**

Chrome Vanadium steel, with knurling,  
Half polished, Half matt, Bulk

Nr. 512 120E8	E8
Nr. 512 120E10	E10
Nr. 512 120E11	E11
Nr. 512 120E12	E12
Nr. 512 120E14	E14
Nr. 512 120E16	E16
Nr. 512 120E18	E18
Nr. 512 120E20	E20
Nr. 512 120E22	E22
Nr. 512 120E24	E24

**1/2" Dr. E-TX Deep Sockets**

Chrome Vanadium steel, with knurling,  
Half polished, Half matt, Bulk

Nr. 512 D120E10	E10
Nr. 512 D120E11	E11
Nr. 512 D120E12	E12
Nr. 512 D120E14	E14
Nr. 512 D120E16	E16
Nr. 512 D120E18	E18
Nr. 512 D120E20	E20
Nr. 512 D120E22	E22
Nr. 512 D120E24	E24

**1/2" Dr. Bit Adaptor Sockets**

Chrome Vanadium steel,  
Matt finish, Bulk

Nr. 512 AD4065	1/2" x 1/4"
Nr. 512 AD4008	1/2" x 5/16"
Nr. 512 AD4010	1/2" x 10mm
Nr. 512 AD4014	1/2" x 14mm

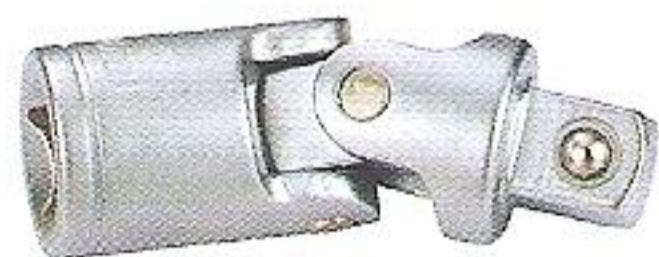
**1/2" Dr. Universal Joint**

Chrome Vanadium steel,  
Matt finish, Bulk

Nr. 512 1212UJ

**1/2" Dr. Extension Bar**

Chrome Vanadium steel,  
Matt finish, Bulk

Nr. 512 4075EX	75mm
Nr. 512 4125EX	125mm
Nr. 512 4250EX	250mm

**1/2" Dr. Wobble Extension Bar**

Chrome Vanadium steel,  
Matt finish, Bulk

Nr. 512 W4125EX 125mm



**1/2" Dr. Flexible Extension Bar**

Chrome Vanadium steel,  
Chrome plated, Bulk

Nr. 512 F0185 185mm



**1/2" Dr. Sliding T-Bar**

Chrome Vanadium steel,  
Matt finish, Bulk

Nr. 512 4250ST 250mm



**1/2" Dr. T-M Head**

Chrome Vanadium steel,  
Matt finish, Bulk

Nr. 512 AD1238 1/2"(M) x 3/8"(F)



**1/2" Dr. Magnetic Spark Plug Sockets**

Chrome Vanadium steel, Chrome plated  
With magnetic inside, Bulk

Nr. 512 M6016 16mm  
Nr. 512 M6021 21mm





**1/2" Dr. Spark Plug Sockets**

Chrome Vanadium steel,  
Matt finish, Bulk

Nr. 512 6016	16mm
Nr. 512 6018	18mm
Nr. 512 6021	21mm



**1/2" Dr. Slotted Bit Sockets**

Chrome Vanadium steel, with knurling,  
Matt finish, Bulk

Nr. 512 1705S	5mm
Nr. 512 17055S	5.5mm
Nr. 512 1707S	7mm
Nr. 512 1708S	8mm



**1/2" Dr. Phillip Bit Sockets**

Chrome Vanadium steel, with knurling,  
Matt finish, Bulk

Nr. 512 1800PH	PH#0
Nr. 512 1801PH	PH#1
Nr. 512 1802PH	PH#2
Nr. 512 1803PH	PH#3



**1/2" Dr. POZI Bit Sockets**

Chrome Vanadium steel, with knurling,  
Matt finish, Bulk

Nr. 512 1900PZ	PZ#0
Nr. 512 1901PZ	PZ#1
Nr. 512 1902PZ	PZ#2
Nr. 512 1903PZ	PZ#3

**1/2" Dr. Hex. Bit Sockets**



**1/2" Dr. Hex Bit Sockets**

Chrome Vanadium steel, with knurling,  
Matt finish, Bulk

Nr. 512 1503H	H3
Nr. 512 1504H	H4
Nr. 512 1505H	H5
Nr. 512 1506H	H6
Nr. 512 1507H	H7
Nr. 512 1508H	H8
Nr. 512 1510H	H10



**1/2" Dr. TX Bit Sockets**

Chrome Vanadium steel, with knurling,  
Matt finish, Bulk

Nr. 512 1610T	T10	Nr. 512 1630T	T30
Nr. 512 1615T	T15	Nr. 512 1640T	T40
Nr. 512 1620T	T20	Nr. 512 1645T	T45
Nr. 512 1625T	T25	Nr. 512 1650T	T50
Nr. 512 1627T	T27	Nr. 512 1655T	T55

## 1/2" Dr. Long TX Bit Sockets

Chrome Vanadium steel, with knurling,  
Matt finish, Bulk

Nr. 512 L1620T	T20
Nr. 512 L1625T	T25
Nr. 512 L1627T	T27
Nr. 512 L1630T	T30
Nr. 512 L1640T	T40
Nr. 512 L1645T	T45
Nr. 512 L1650T	T50
Nr. 512 L1655T	T55

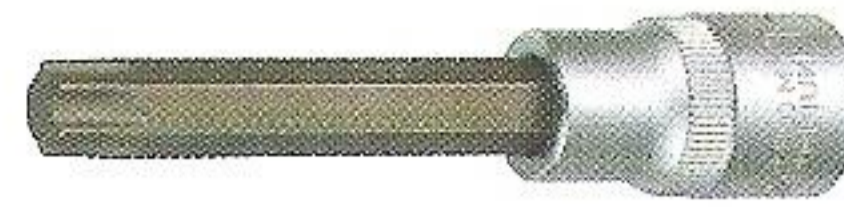

## 1/2" Dr. Long Spline Bit Sockets

Chrome Vanadium steel, with knurling,  
Matt finish, Bulk

Nr. 512 L2205M	M5
Nr. 512 L2206M	M6
Nr. 512 L2207M	M7
Nr. 512 L2208M	M8
Nr. 512 L2210M	M10
Nr. 512 L2212M	M12



## 1/2" Dr. Long Ball Point Bit Sockets

Chrome Vanadium steel, with knurling,  
Matt finish, Bulk

Nr. 512 L2104B	4mm
Nr. 512 L2105B	5mm
Nr. 512 L2106B	6mm
Nr. 512 L2107B	7mm
Nr. 512 L2108B	8mm
Nr. 512 L2110B	10mm

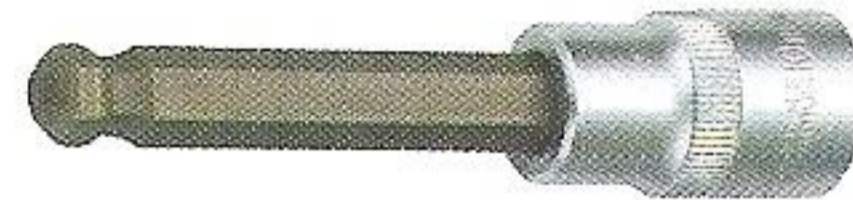

## 1/2" Dr. Long Hex. Bit Sockets

Chrome Vanadium steel, with knurling,  
Matt finish, Bulk

Nr. 512 L1504H	4mm
Nr. 512 L1506H	6mm
Nr. 512 L1507H	7mm
Nr. 512 L1508H	8mm
Nr. 512 L1510H	10mm



## 1/2" Dr. Combined Socket For Alternator

Long bit & Sliding socket,  
Chrome Vanadium steel,  
Matt finish, Bulk

Nr. 512 L1010M	M10
Nr. 512 L1050T	T50





**Nr. 520 2015**

**15-pcs 3/4" FLANK Dr. Socket Wrench Set**

Chrome Vanadium steel, 6 point Matt finish,  
Packed in metal case

Consisting of:

11 x Sockets 3/4": 19 - 22 - 24 - 27 - 30 - 32  
36 - 38 - 41 - 46 - 50mm

1 x Reversible Ratchet Handle 3/4" - 450mm

1 x Sliding T-Bar 3/4" - 450mm

2 x Extension bars 3/4": 100mm - 200mm

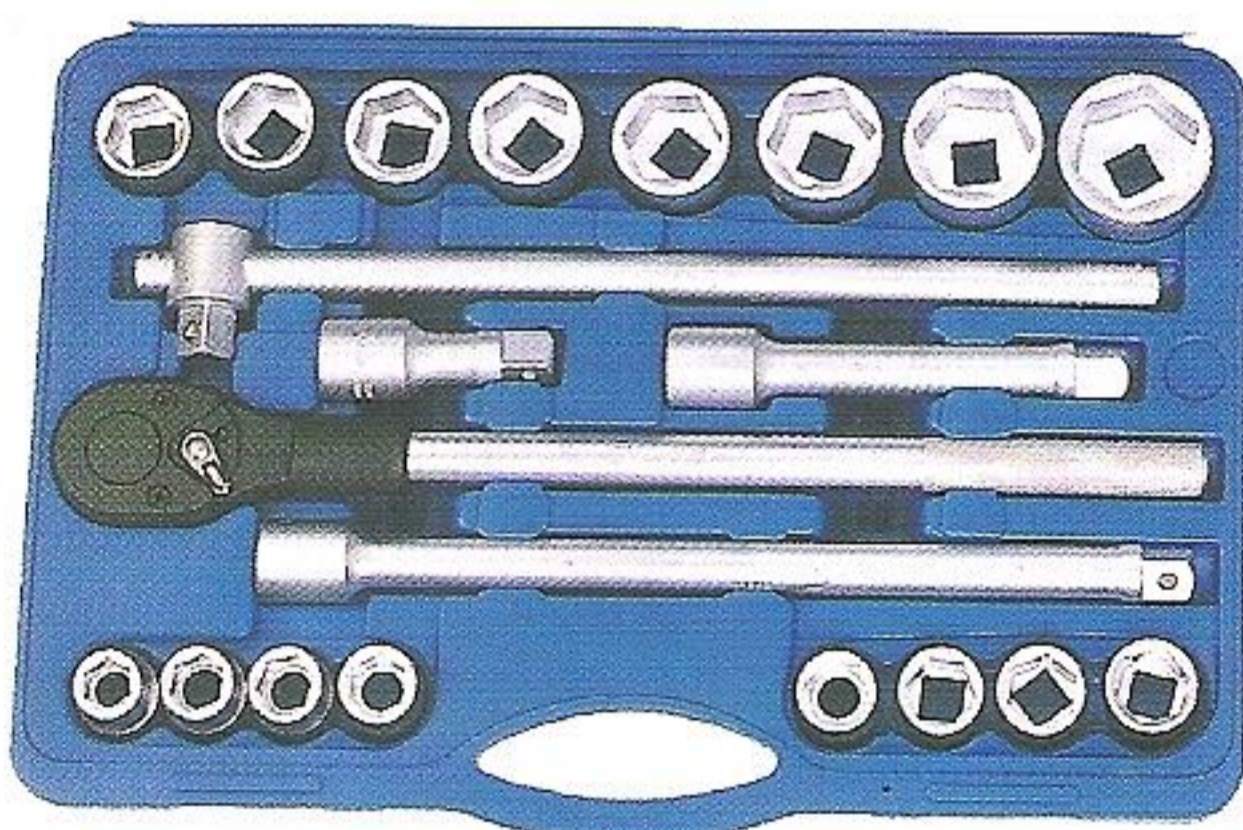

**Nr. 520 1022**

**22-pcs 3/4" FLANK Dr. Socket Wrench Set**

Chrome Vanadium steel, 6 point with hole,  
Matt finish, Packed in BMC

Consisting of:

16 x Sockets 3/4": 19 - 21 - 22 - 23 - 24 - 26  
27 - 28 - 30 - 32 - 34 - 36  
38 - 41 - 46 - 50mm

3 x Extension bar 3/4": 100mm - 200mm - 400mm

1 x Reversible Ratchet Handle 3/4" - 500mm

1 x Sliding T-bar 3/4" - 450mm

1 x T-M Head 3/4"

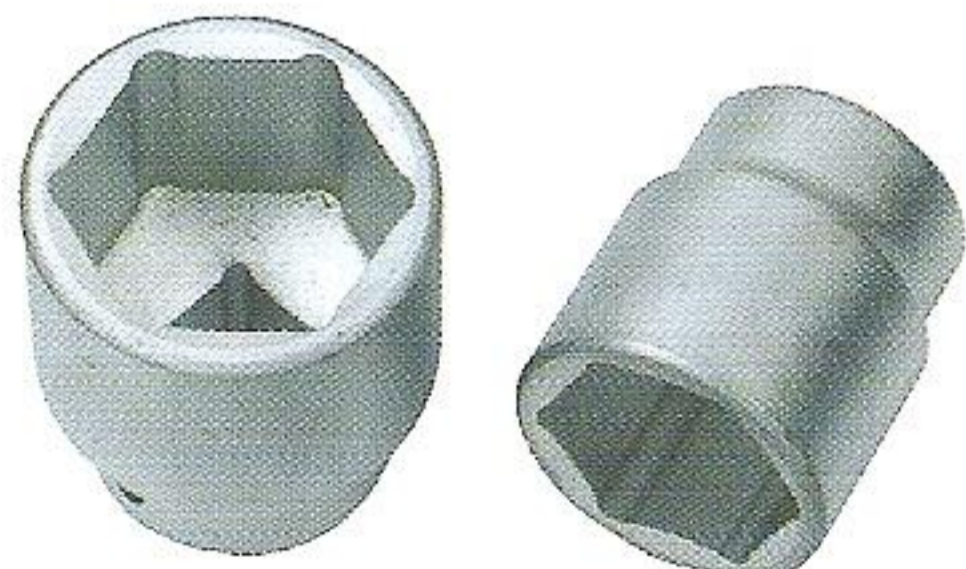

**3/4" FLANK Dr. Individual Sockets**

Chrome Vanadium steel, 6 point with hole,  
Matt finish, Bulk

Nr. 519 1019	19mm	Nr. 519 1032	32mm
Nr. 519 1021	21mm	Nr. 519 1034	34mm
Nr. 519 1022	22mm	Nr. 519 1035	35mm
Nr. 519 1023	23mm	Nr. 519 1036	36mm
Nr. 519 1024	24mm	Nr. 519 1038	38mm
Nr. 519 1025	25mm	Nr. 519 1041	41mm
Nr. 519 1026	26mm	Nr. 519 1046	46mm
Nr. 519 1027	27mm	Nr. 519 1050	50mm
Nr. 519 1028	28mm	Nr. 519 1055	55mm
Nr. 519 1029	29mm	Nr. 519 1056	56mm
Nr. 519 1030	30mm	Nr. 519 1060	60mm



**Nr. 519 RH24**

**3/4" Dr. Reversible Ratchet Handle**  
 Chrome Vanadium steel,  
 Matt finish, Bulk.



**3/4" FLANK. Dr. Extension Bars**  
 Chrome Vanadium steel,  
 Matt finish, Bulk.

**Nr. 519 EX100**            100mm  
**Nr. 519 EX200**            200mm  
**Nr. 519 EX400**            400mm



**3/4" Dr. Sliding T-Bar**  
 Chrome Vanadium steel,  
 Matt finish, Bulk

**Nr. 519 ST450**            450mm



**1" Dr. Universal Ratchet Handle**  
 Chrome Vanadium steel, 30 teeth  
 Matt finish, Bulk

**Nr. 525 UH550**            550mm



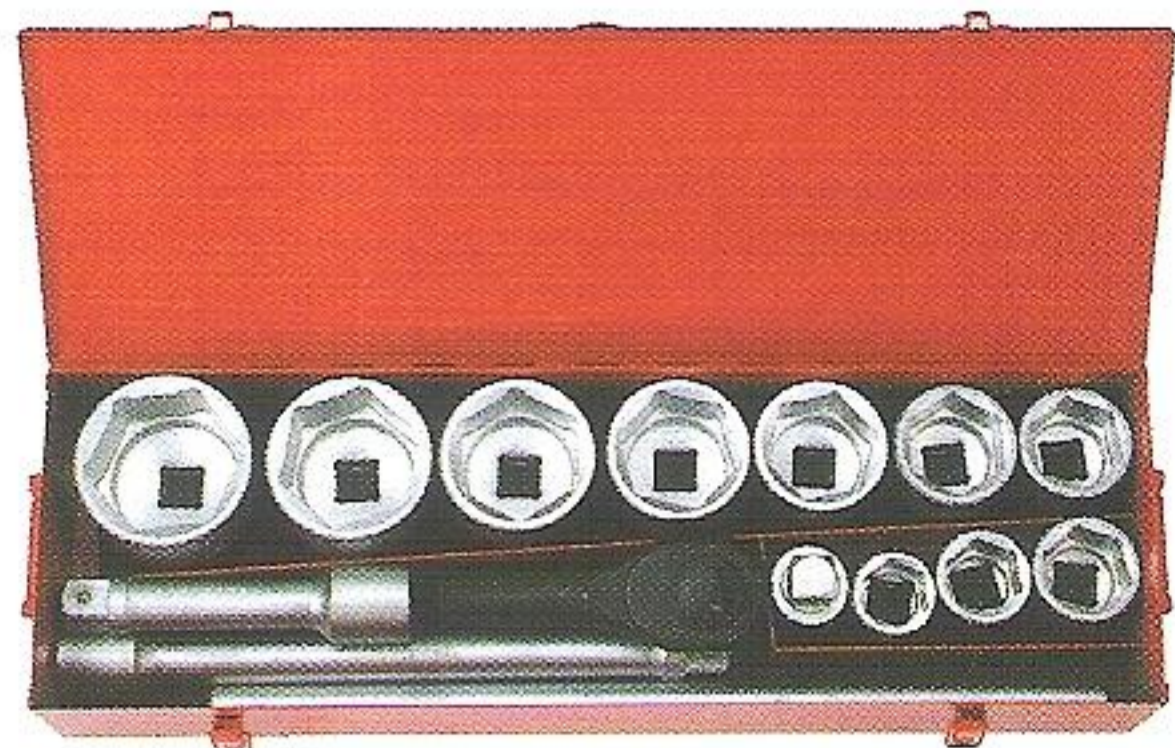

**Nr. 525 1016**

**16-pcs 1" FLANK Dr. Socket Wrench Set**

Chrome Vanadium steel, 6 Points, with hole  
Matt finish, Packed in metal case.

Consisting of:

11 x Sockets 1": 36 - 38 - 41 - 46 - 50 - 55  
60 - 65 - 70 - 75 - 80mm

1 x T - Head - 79mm  
1 x PRO. Ratchet handle head  
1 x Universal handle - 550mm  
1 x Extension bar - 220mm  
1 x Extension bar - 400mm

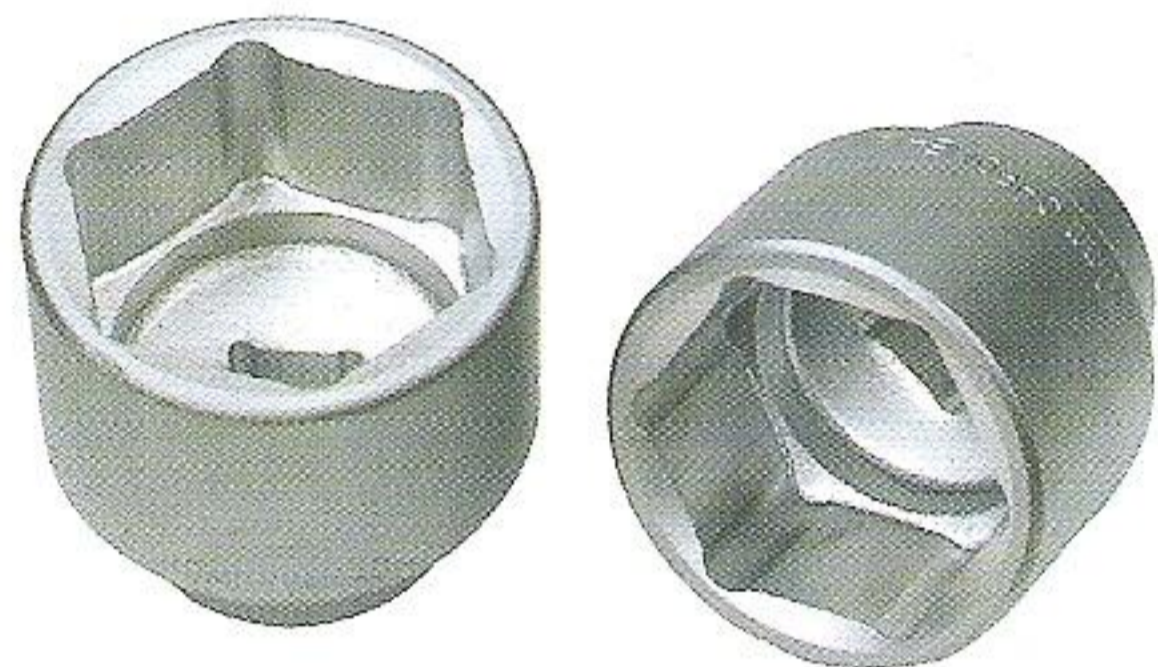

**1" FLANK Dr. Individual Sockets**

Chrome Vanadium steel,  
Matt finish, Bulk

Nr. 525 1036	36mm	Nr. 525 1063	63mm
Nr. 525 1038	38mm	Nr. 525 1065	65mm
Nr. 525 1041	41mm	Nr. 525 1067	67mm
Nr. 525 1046	46mm	Nr. 525 1070	70mm
Nr. 525 1050	50mm	Nr. 525 1071	71mm
Nr. 525 1054	54mm	Nr. 525 1075	75mm
Nr. 525 1055	55mm	Nr. 525 1077	77mm
Nr. 525 1058	58mm	Nr. 525 1080	80mm
Nr. 525 1060	60mm		



**1" Dr. Sliding T-M Head**

Chrome Vanadium steel,  
Matt finish, Bulk

Nr. 525 TS10 79mm

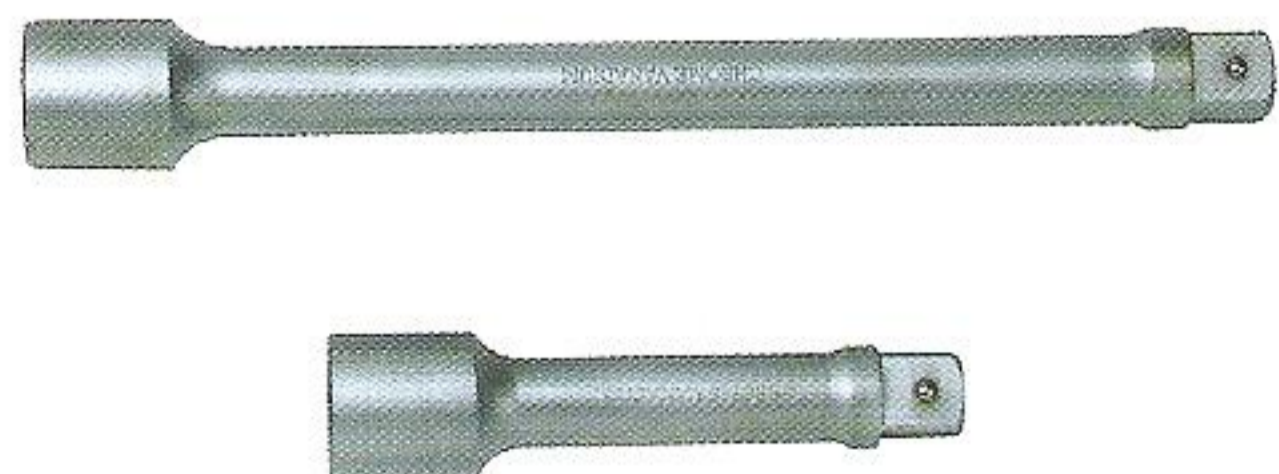

**1" FLANK. Dr. Extension Bars**

Chrome Vanadium steel,  
Matt finish, Bulk

Nr. 525 EX200 200mm  
Nr. 525 EX400 400mm

### 1/4" PH-Bits

Chrome Vanadium steel,  
Sand finishing, Bulk

Length	25mm	50mm	75mm
PH0	<b>510PH0</b>	<b>511PH0</b>	<b>512PH0</b>
PH1	<b>510PH1</b>	<b>511PH1</b>	<b>512PH1</b>
PH2	<b>510PH2</b>	<b>511PH2</b>	<b>512PH2</b>
PH3	<b>510PH3</b>	<b>511PH3</b>	<b>512PH3</b>



### 1/4" PZ-Bits

Chrome Vanadium steel,  
Sand finishing, Bulk

Length	25mm	50mm	75mm
PZ0	<b>510PZ0</b>	<b>511PZ0</b>	<b>512PZ0</b>
PZ1	<b>510PZ1</b>	<b>511PZ1</b>	<b>512PZ1</b>
PZ2	<b>510PZ2</b>	<b>511PZ2</b>	<b>512PZ2</b>
PZ3	<b>510PZ3</b>	<b>511PZ3</b>	<b>512PZ3</b>



### 1/4" Slotted-Bits

Chrome Vanadium steel,  
Sand finishing, Bulk

Length	25mm	50mm	75mm
4mm	<b>510S40</b>	<b>511S40</b>	<b>512S40</b>
4.5mm	<b>510S45</b>	<b>511S45</b>	<b>512S45</b>
5.5mm	<b>510S55</b>	<b>511S55</b>	<b>512S55</b>
6mm	<b>510S60</b>	<b>511S60</b>	<b>512S60</b>
6.5mm	<b>510S65</b>	<b>511S65</b>	<b>512S65</b>
8mm	<b>510S80</b>	<b>511S80</b>	<b>512S80</b>



### 1/4" Hexagon-Bits

Chrome Vanadium steel,  
Sand finishing, Bulk

Length	25mm	50mm	75mm
3mm	<b>510H30</b>	<b>511H30</b>	<b>512H30</b>
4mm	<b>510H40</b>	<b>511H40</b>	<b>512H40</b>
5mm	<b>510H50</b>	<b>511H50</b>	<b>512H50</b>
6mm	<b>510H60</b>	<b>511H60</b>	<b>512H60</b>
7mm	<b>510H70</b>	<b>511H70</b>	<b>512H70</b>
8mm	<b>510H80</b>	<b>511H80</b>	<b>512H80</b>



### 1/4" Hexagon Security Bits

Tamperproofed,  
Chrome Vanadium steel,  
S2 Sand finishing, Bulk

Length	25mm	50mm	75mm
2mm	<b>510TH20</b>	<b>511TH20</b>	<b>512TH20</b>
2.5mm	<b>510TH25</b>	<b>511TH25</b>	<b>512TH25</b>
3mm	<b>510TH30</b>	<b>511TH30</b>	<b>512TH30</b>
4mm	<b>510TH40</b>	<b>511TH40</b>	<b>512TH40</b>
5mm	<b>510TH50</b>	<b>511TH50</b>	<b>512TH50</b>
6mm	<b>510TH60</b>	<b>511TH60</b>	<b>512TH60</b>



**1/4" TX-Bits**

Chrome Vanadium steel,  
Sand Finishing, Bulk



Length	25mm	50mm	75mm
T7	510TX7	511TX7	512TX7
T8	510TX8	511TX8	512TX8
T9	510TX9	511TX9	512TX9
T10	510TX10	511TX10	512TX10
T15	510TX15	511TX15	512TX15
T20	510TX20	511TX20	512TX20
T25	510TX25	511TX25	512TX25
T27	510TX27	511TX27	512TX27
T30	510TX30	511TX30	512TX30
T40	510TX40	511TX40	512TX40

**1/4" TX-Bits**

Tamperproofed, Chrome Vanadium steel,  
S2 Sand finishing, Bulk



Length	25mm	50mm	75mm
T7	510TP7	511TP7	512TP7
T8	510TP8	511TP8	512TP8
T9	510TP9	511TP9	512TP9
T10	510TP10	511TP10	512TP10
T15	510TP15	511TP15	512TP15
T20	510TP20	511TP20	512TP20
T25	510TP25	511TP25	512TP25
T27	510TP27	511TP27	512TP27
T30	510TP30	511TP30	512TP30
T40	510TP40	511TP40	512TP40

**1/4" Spanner Security Bits**

Chrome Vanadium steel,  
Sand finishing, Bulk



Length	25mm	50mm	75mm
4	510SP40	511SP40	512SP40
6	510SP60	511SP60	512SP60
8	510SP80	511SP80	512SP80
10	510SP100	511SP100	512SP100

**1/4" Tri-Wing Security Bits**

Chrome Vanadium steel,  
Sand finishing, Bulk



Length	25mm	50mm	75mm
4	510TW40	511TW40	512TW40
6	510TW60	511TW60	512TW60
8	510TW80	511TW80	512TW80
10	510TW100	511TW100	512TW100

**1/4" Torque Security Bits**

Chrome Vanadium steel,  
Sand finishing, Bulk



Length	25mm	50mm	75mm
6	510TR60	511TR60	512TR60
8	510TR80	511TR80	512TR80
10	510TR100	511TR100	512TR100

**TX-Bits 10mm,**  
 Chrome Vanadium steel,  
 Sand finishing, Bulk

Length	30mm	75mm
T10	516TX10	518TX10
T15	516TX15	518TX15
T20	516TX20	518TX20
T25	516TX25	518TX25
T27	516TX27	518TX27
T30	516TX30	518TX30
T40	516TX40	518TX40
T45	516TX45	518TX45
T50	516TX50	518TX50
T55	516TX55	518TX55
T60	516TX60	518TX60



**TX-Bits 10mm,**  
 Tamperproofed, Chrome Vanadium steel,  
 S2 Sand finishing, Bulk

Length	30mm	75mm
T10	516TP10	518TP10
T15	516TP15	518TP15
T20	516TP20	518TP20
T25	516TP25	518TP25
T27	516TP27	518TP27
T30	516TP30	518TP30
T40	516TP40	518TP40
T45	516TP45	518TP45
T50	516TP50	518TP50
T55	516TP55	518TP55
T60	516TP60	518TP60



**Spline(XZN)-Bits 10mm,**  
 Chrome Vanadium steel,  
 Sand finishing, Bulk

Length	30mm	75mm
M5	516M5	518M5
M6	516M6	518M6
M8	516M8	518M8
M10	516M10	518M10
M12	516M12	518M12



**Hexagon-Bits 10mm,**  
 Chrome Vanadium steel,  
 Sand Finishing, Bulk

Length	30mm	75mm
4	516H4	518H4
5	516H5	518H5
6	516H6	518H6
7	516H7	518H7
8	516H8	518H8
10	516H10	518H10
12	516H12	518H12

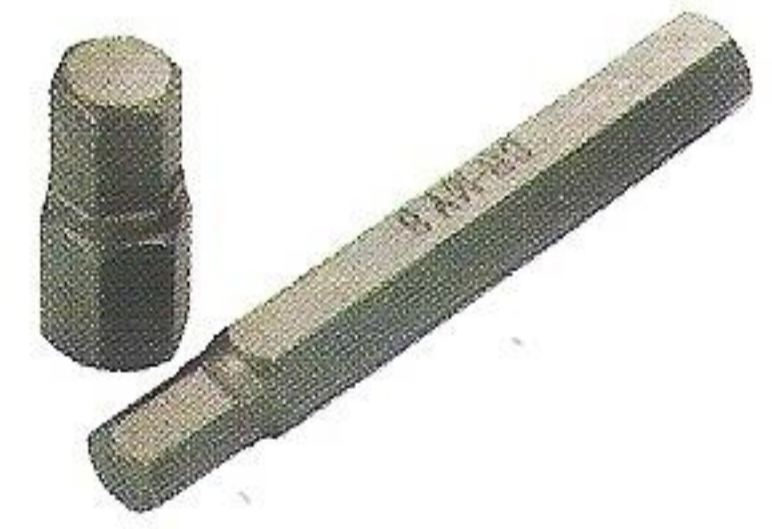



**Slotted-Bits**, Length 30mm x 10mm,  
Chrome Vanadium steel,  
Sand finishing, Bulk

8mm	<b>Nr. 516 S80</b>
10mm	<b>Nr. 516 S100</b>



**PH-Bits**, Length 30mm x 10mm,  
Chrome Vanadium steel,  
Sand finishing, Bulk

PH1	<b>516PH1</b>
PH2	<b>516PH2</b>
PH3	<b>516PH3</b>



**Ribe Bits** 10mm,  
Chrome Vanadium steel,  
Sand finishing, Bulk

Length	40mm	75mm
M5	<b>516R5</b>	<b>518R5</b>
M6	<b>516R6</b>	<b>518R6</b>
M7	<b>516R7</b>	<b>518R7</b>
M8	<b>516R8</b>	<b>518R8</b>
M9	<b>516R9</b>	<b>518R9</b>
M10	<b>516R10</b>	<b>518R10</b>
M11	<b>516R11</b>	<b>518R11</b>
M12	<b>516R12</b>	<b>518R12</b>
M13	<b>516R13</b>	<b>518R13</b>



**Extra Long Magnetic Bit Holder**,  
With quick release,  
Stainless housing with strong magnetic.  
Bulk



<b>Nr. 517 2150</b>	1/4" x 150mm
<b>Nr. 517 2300</b>	1/4" x 300mm

**Nr. 710 TH108**

**8-pcs T-Handle Hex Key Wrench Set**

Chrome Vanadium steel, Matt finish  
Packed in metal stand with box

Consisting of: 2 - 3 - 4 - 5 - 6 - 7 - 8 - 10mm



**Nr. 710 TX109**

**9-pcs T-Handle TX Key Wrench Set**

Chrome Vanadium steel, Matt finish  
Packed in metal stand with box

Consisting of: TX10 - TX15 - TX20 - TX25 - TX27  
TX30 - TX40 - TX45 - TX50



**Nr. 710 LH109**

**9-pcs Extra Long Hex. Key Wrench Set**

Chrome Vanadium steel, Matt finish,  
Packed in plastic holder, Carded.

Consisting of: 1.5 - 2 - 2.5 - 3 - 4 - 5 - 6 - 8 - 10mm



**Nr. 710 LBH109**

**9-pcs Extra Long Ball Point Hex Key Wrench Set**

Chrome Vanadium steel, Matt finish,  
Packed in plastic holder, Carded.

Consisting of: 1.5 - 2 - 2.5 - 3 - 4 - 5 - 6 - 8 - 10mm



**Nr. 710 LTX109**

**9-pcs Extra Long TX Key Wrench Set**

Chrome Vanadium steel, Nickel plated,  
Packed in plastic holder, Carded.

Consisting of: TX10 - TX15 - TX20 - TX25 - TX27  
TX30 - TX40 - TX45 - TX50



Nr. 600 3030



Nr. 600 3110



Nr. 600 4210



Nr. 600 4350



Nr. 600 6500



Nr. 600 6700



Nr. 600 6980



Nr. 600 3030	3/8" Dr.	6 - 30 Nm	350mm
Nr. 600 3110	3/8" Dr.	19 - 110 Nm	385mm
Nr. 600 4210	1/2" Dr.	40 - 210 Nm	535mm
Nr. 600 4350	1/2" Dr.	70 - 350 Nm	645mm
Nr. 600 6500	3/4" Dr.	100 - 500 Nm	865mm
Nr. 600 6700	3/4" Dr.	140 - 700 Nm	1092mm
Nr. 600 6980	3/4" Dr.	140 - 980 Nm	1230mm

Nr. 610 6013



Nr. 610 6014



Nr. 610 6015



Nr. 610 6016



Nr. 610 6013	3/8" Dr.	14 - 110 Nm	275mm
Nr. 610 6014	1/2" Dr.	30 - 210 Nm	465mm
Nr. 610 6015	1/2" Dr.	70 - 350 Nm	630mm
Nr. 610 6016	1/2" Dr.	27 - 176 Nm	480mm





**T-Handle Nut Drivers, Length 270mm**  
 Chrome Vanadium steel shaft,  
 Matt finish, with confort grip. Bulk

Nr. 638 1005	5mm
Nr. 638 1006	6mm
Nr. 638 1007	7mm
Nr. 638 1008	8mm
Nr. 638 1009	9mm
Nr. 638 1010	10mm
Nr. 638 1011	11mm
Nr. 638 1012	12mm
Nr. 638 1013	13mm
Nr. 638 1014	14mm



**Extra Long T-Handle Swivel Spark Plug Sockets**  
 With coated T-Handle, Bulk

Nr. 637 4014	370mm	14mm
Nr. 637 4016	370mm	16mm
Nr. 637 4021	370mm	21mm



**Swivel Spark Plug Sockets**  
 With coated T-Handle, Bulk

Nr. 637 8016	230mm	16mm
Nr. 637 8021	230mm	21mm
Nr. 637 8116S	230mm ( With spring )	16mm
Nr. 637 8121S	230mm ( With spring )	21mm



**Nr. 709 5100**

**Small Cross Wrench**  
 Carbon steel, Chrome plated  
 In length of 190mm  
 Size: 10 - 12 - 14 - 17mm

## 2-WAY Reversible Gear Wrenches

Chrome Vanadium steel (CR-V 6140), 15° offset  
Fully mirror polish, Chrome plated  
72 Teeth mechanism, Bulk

Nr. 660 1008	8mm	140mm
Nr. 660 1009	9mm	149mm
Nr. 660 1010	10mm	159mm
Nr. 660 1011	11mm	165mm
Nr. 660 1012	12mm	172mm
Nr. 660 1013	13mm	178mm
Nr. 660 1014	14mm	191mm
Nr. 660 1015	15mm	200mm
Nr. 660 1016	16mm	208mm
Nr. 660 1017	17mm	225mm
Nr. 660 1018	18mm	237mm
Nr. 660 1019	19mm	248mm



## Nr. 650 1008

8-pcs Two Ways Gear Wrench Set in BMC

Consisting of: 8 - 10 - 11 - 12 - 13 - 14 - 17 - 19mm



## Nr. 650 1012

12-pcs Two Ways Gear Wrench Set in BMC

Consisting of: 8 - 9 - 10 - 11 - 12 - 13 - 14 - 15  
16 - 17 - 18 - 19mm



## One-Way Gear Wrenches

Chrome Vanadium steel, (CR-V 6140), Flat type  
Fully mirror polish, Chrome plated,  
72 Teeth mechanism, Bulk

Nr. 660 3006	6mm	140mm
Nr. 660 3007	7mm	140mm
Nr. 600 3008	8mm	140mm
Nr. 600 3009	9mm	158mm
Nr. 600 3010	10mm	158mm
Nr. 600 3011	11mm	165mm
Nr. 600 3012	12mm	169mm
Nr. 600 3013	13mm	173mm
Nr. 600 3014	14mm	189mm
Nr. 600 3015	15mm	199mm
Nr. 600 3016	16mm	205mm
Nr. 600 3017	17mm	227mm
Nr. 600 3018	18mm	237mm
Nr. 600 3019	19mm	247mm
Nr. 600 3021	21mm	280mm
Nr. 600 3022	22mm	280mm
Nr. 600 3023	23mm	310mm
Nr. 600 3024	24mm	310mm
Nr. 600 3025	25mm	310mm



**E-TX Spanners, Straight Type**  
 Chrome Vanadium steel,  
 Matt finish, Bulk



Nr. 615 E0608	E6 x E8
Nr. 615 E0711	E7 x E11
Nr. 615 E1012	E10 x E12
Nr. 615 E1418	E14 x E18
Nr. 615 E1622	E16 x E22
Nr. 615 E2024	E20 x E24

**Nr. 615 SET4**

**4-pcs E-TX Spanner Set**  
 Chrome Vanadium steel,  
 Matt finish, 4-pcs packed in Polybaged



Consisting of: E 6 x E 8 - E10 x E12  
 E14 x E18 - E20 x E24

**Nr. 615 SET6**

**6-pcs E-TX Spanner Set**  
 Chrome Vanadium steel,  
 Matt finish, 6-pcs packed in tray

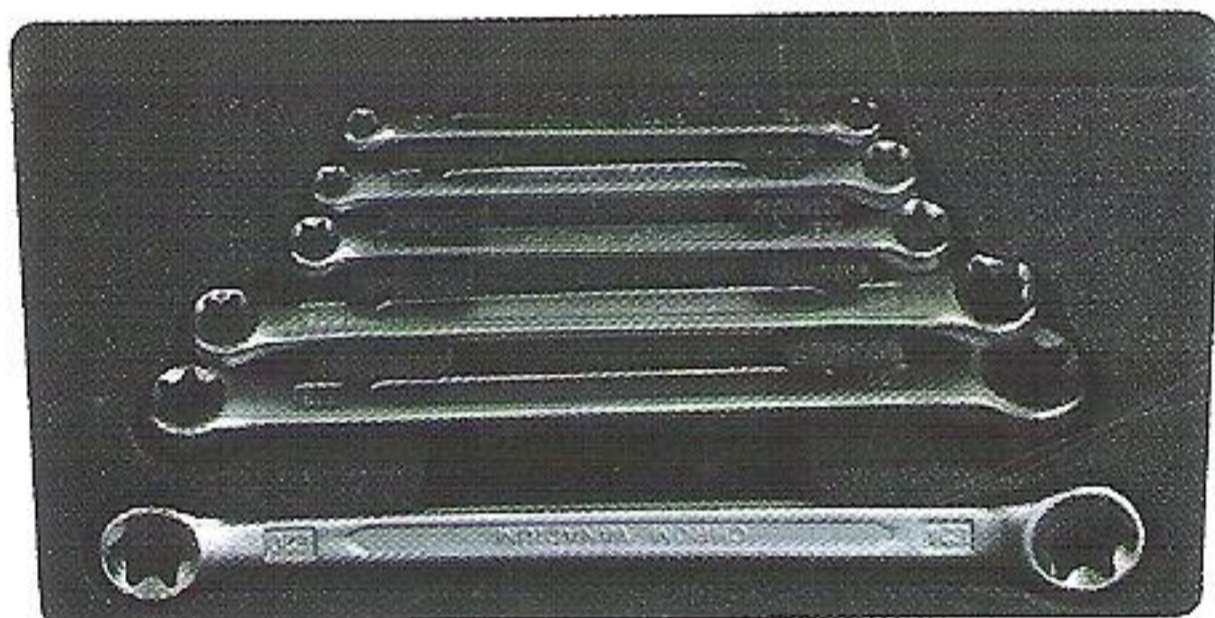

Consisting of: E 6 x E 8 - E 7 x E11  
 E10 x E12 - E14 x E18  
 E16 x E22 - E20 x E24

**Flare Nut Wrench 10° Offset**  
 Chrome Vanadium steel, Polished,  
 Chrome plated, Bulk



Nr. 612 0809	8 x 9mm
Nr. 612 0810	8 x 10mm
Nr. 612 1011	10 x 11mm
Nr. 612 1213	12 x 13mm
Nr. 612 1214	12 x 14mm
Nr. 612 1417	14 x 17mm

**Double Socket Reversible Ratchet, Scaffold Wrench**  
 Chrome Vanadium steel,  
 Matt finish, Bulk

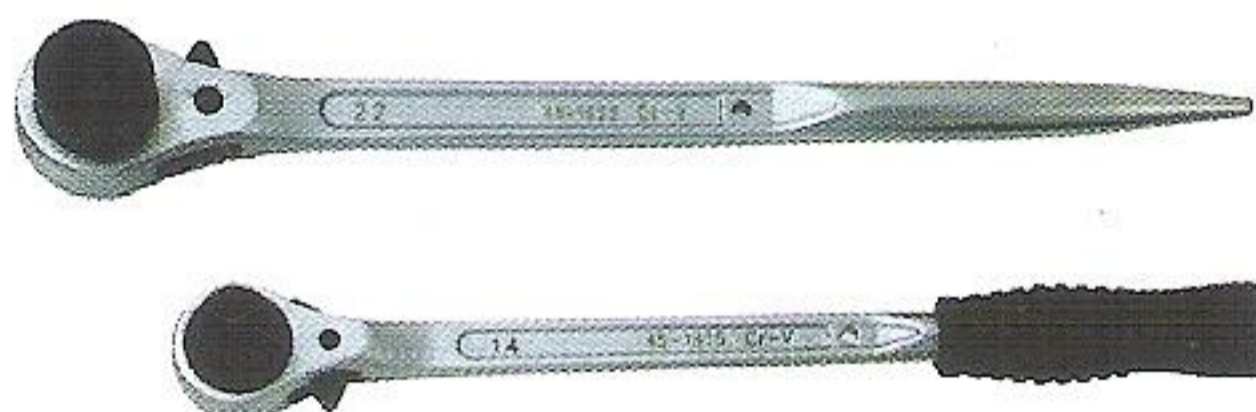

Nr. 689 1415	14mm x 15mm With rubber grip
Nr. 689 1719	17mm x 19mm w/o rubber grip
Nr. 689 1922	19mm x 22mm w/o rubber grip

### Aviation Tin Snips, With Grip

Chrome Vanadium steel, "GS" Approved,  
Cutting sheet metal up to 1.2mm, Carded

- Nr. 623 0100S      Straisht cut, yellow grip
- Nr. 623 0101L      Left cut, red grip
- Nr. 623 0102R      Right cut, green grip

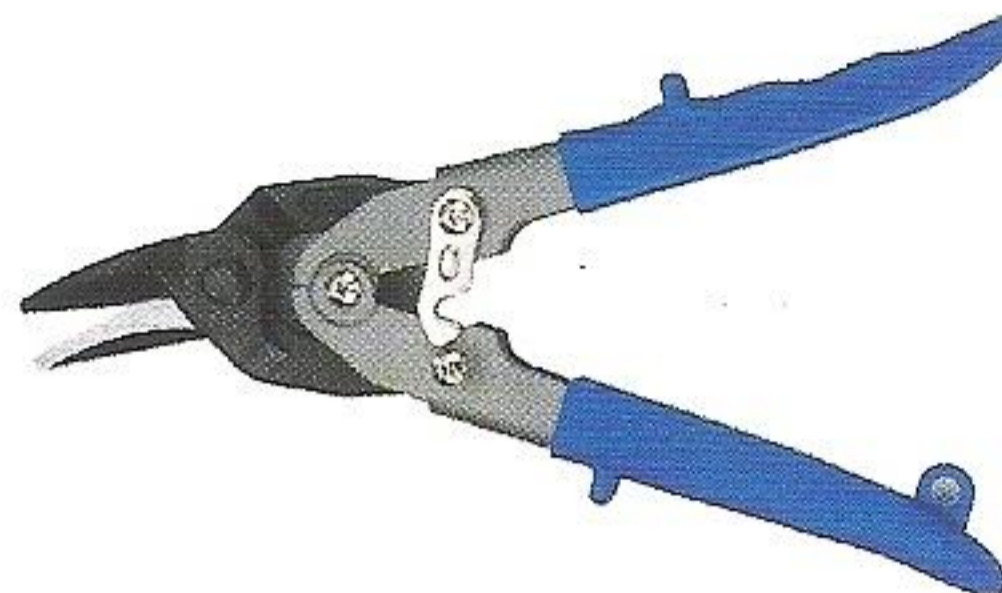

### Straight Pattern Tin Snip

One piece drop forged handle,  
Hardened blade with cushion grip, Carded

- Nr. 624 0250          250mm
- Nr. 624 0300          300mm

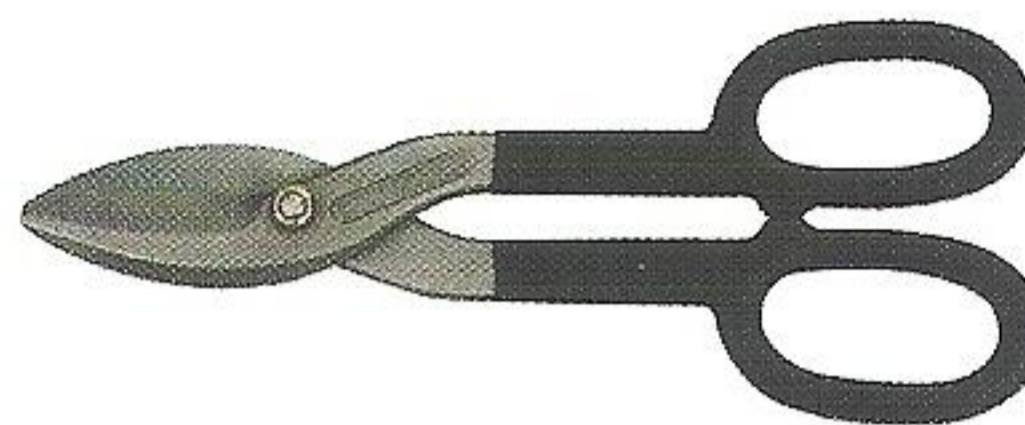

### Tinman's Snip, Blue painted

Drop forged carbon steel,  
Hardened blade with spring loaded, Carded

- Nr. 625 0250          250mm
- Nr. 625 0300          300mm



### Hand Nibbler Shear

Suitable for cutting metal & plastic sheets,  
Interchangeable CR-MO Steel blade  
Carded

- Nr. 626 0250          250mm

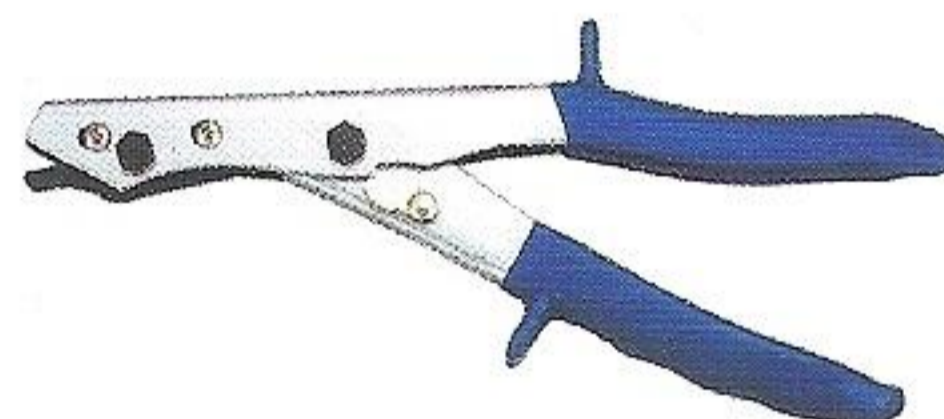

### Stainless Steel Scissors

Stainless Steel, Carded

- Nr. 628 1140          140mm
- Nr. 628 1178          178mm

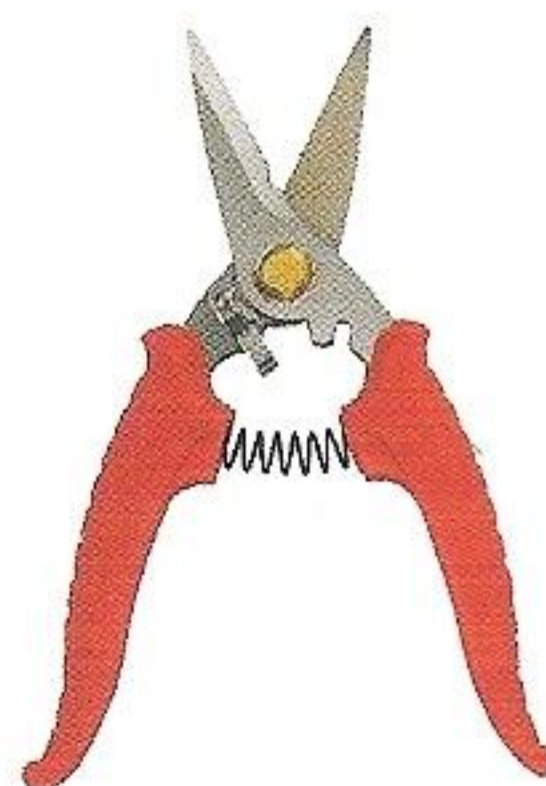

Nr. 628 1178



Nr. 628 1140



**Bolt Cutters,**  
Chrome Vanadium steel, with "GS" Approved,  
Changeable Spare Blade, Each boxed

Nr. 670 0460	18" (460mm)
Nr. 670 0610	24" (610mm)
Nr. 670 0760	30" (760mm)
Nr. 670 0910	36" (910mm)



**Bolt Cutters, "ST" Type.**

Nr. 669 0460	460mm
Nr. 669 0610	610mm
Nr. 669 0760	760mm
Nr. 669 0910	910mm



**Nr. 668 0600**

**Cable Cutter,** Forged High Carbon Steel,  
Hardened blade, Blue painted handle  
With comfortable grip, 600mm in length  
Cutting Capacity:  $\phi$  13mm Wire rope  
Each boxed.

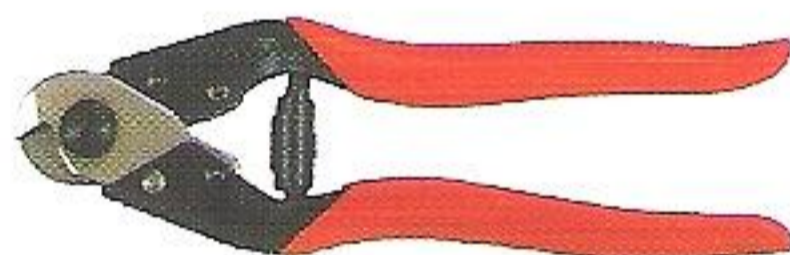

**Nr. 668 0200**

**8" Wire Cutters,**  
Drop forged high carbon steel, hardened blade,  
With coated grip,  
Cutting capacity:  $\phi$  4.5mm wire rope  
Packed in card or pouch

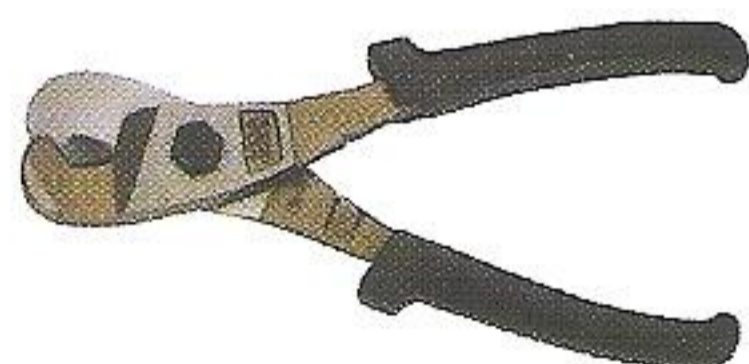

**Nr. 668 0215**

**8-1/4" Cable Cutter,** Drop Forged Steel,  
Hardened blade for  
Cutting capacity  $\phi$  15mm Wire, with  
Plastified grip, Pouch packed

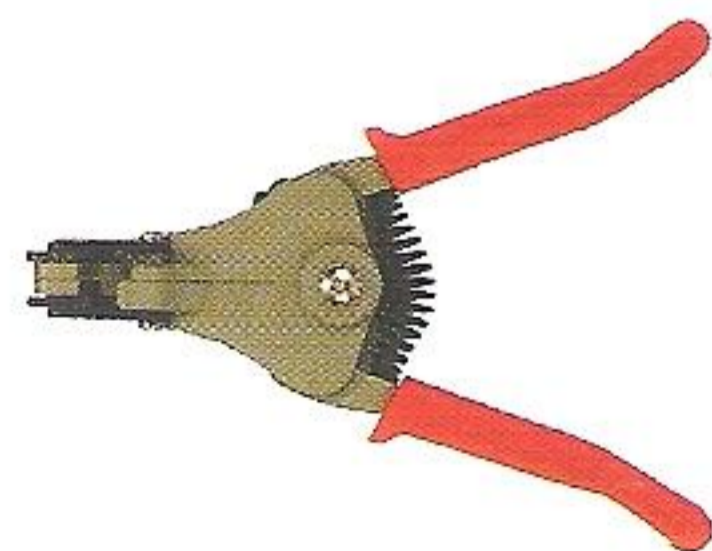

**Automatic Wire Stripper,** VESSEL type,  
With plastic grip, Carded

Nr. 228 0169A	Type A	0.5 - 2.0mm
Nr. 228 0169B	Type B	1.0 - 3.2mm

Nr. 704 3150

**Master Wheel Rim Wrench**  
 Chrome Vanadium steel socket,  
 Fit for 17 & 19mm wheel nut, Carded

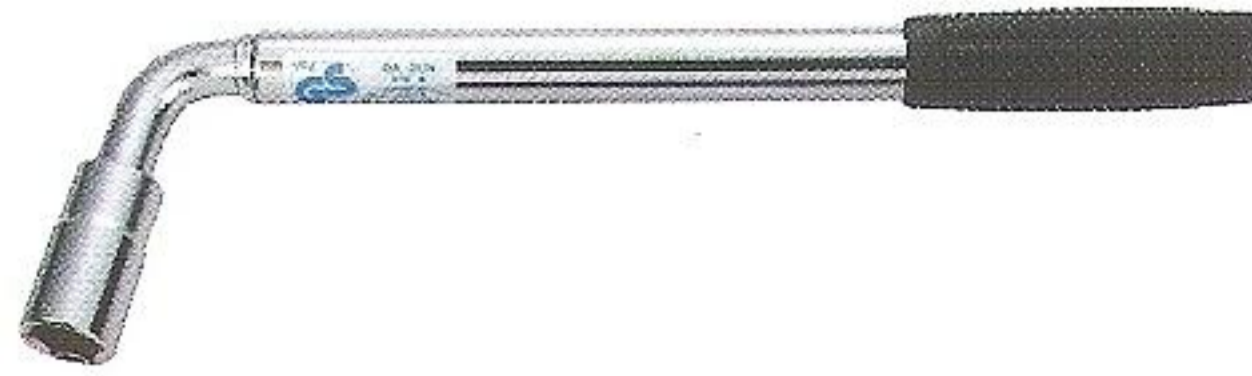

Nr. 224 2500

**Impact Driver With 4 Bits With**  
 Metal ring, in metal case.



Nr. 704 6050

**5-pcs Swivel Tune-Up Kits**  
 Carbon steel, Chrome plated  
 Packed in card



Nr. 704 7190

**Balancing Weight Plier 190mm**  
 Forged Carbon steel, Matt finish  
 With black coated grip, Bulk

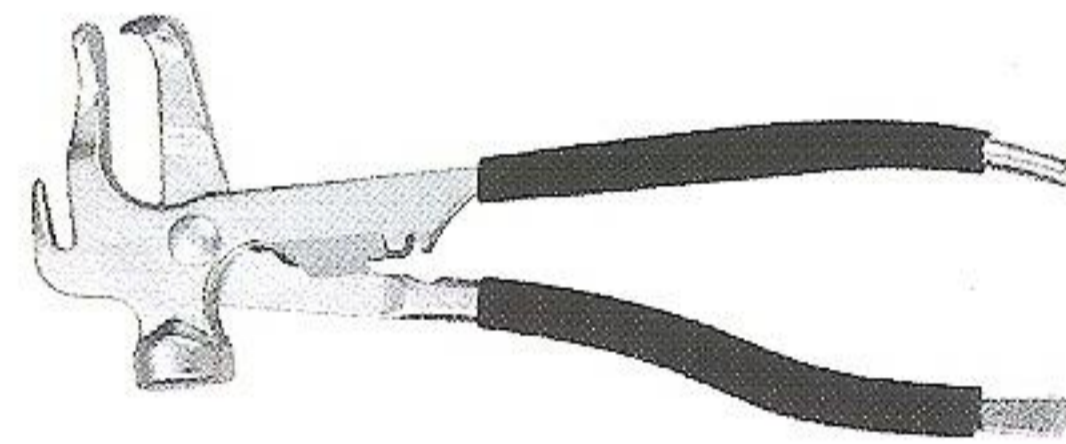

Nr. 233 0120

**360° Swivel Hand Riveter, Boxed.**  
 Capacity: 2.4 - 3 - 4 - 4.8mm

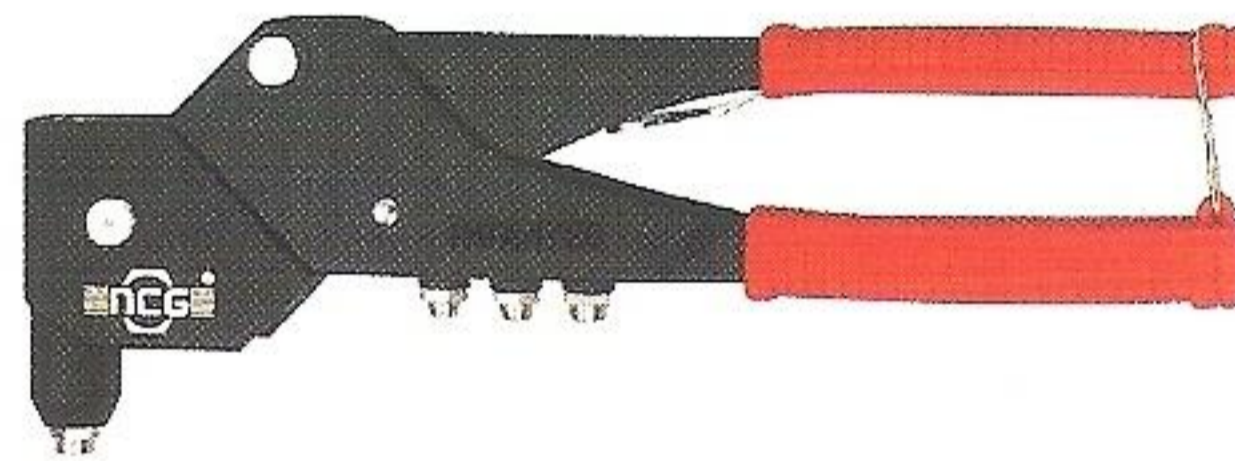

**Sketelon Caulking Gun, Die Cast**  
 Frame with painted, Bulk

Nr. 714 0090 9"  
 Nr. 714 0150 10 1/2"

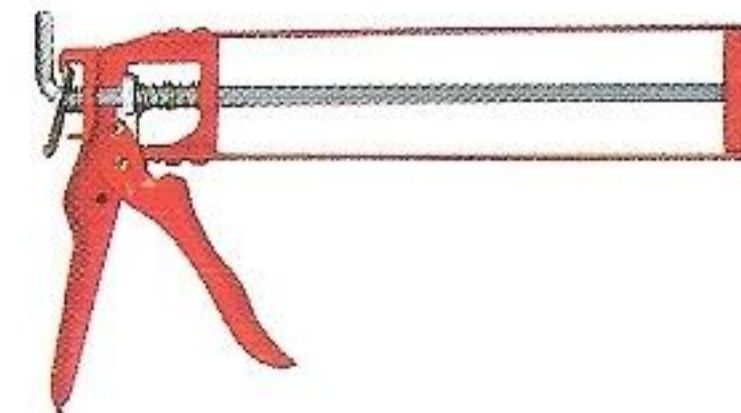

**ALUM. TUBE Caulking Guns, Bulk**

Nr. 714 3090 9"  
 Nr. 714 3120 12"





Nr. 705 3100

**4" Vacuum Suction Cup**

Professional suction cup for heavy job,  
Holding glass, tile & marble, etc.  
Color boxed.

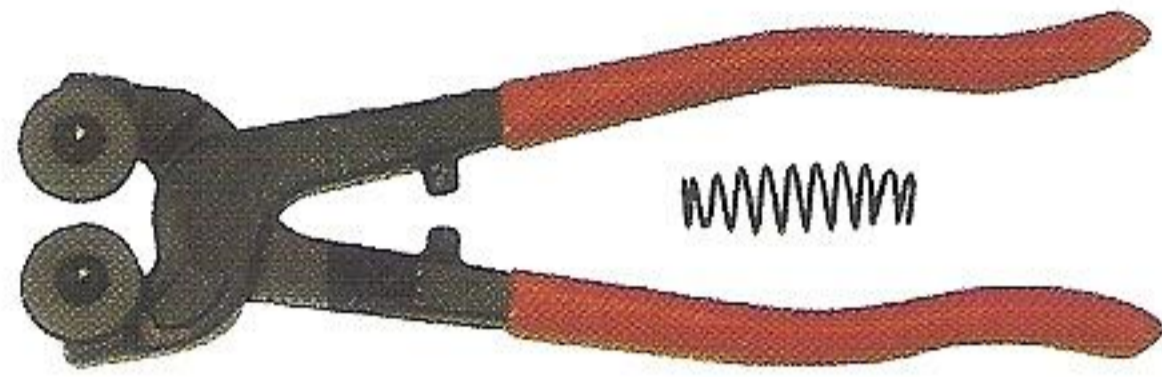

Nr. 705 2200

**8" 2 in One Glass Cutter & Nipper**

Drop forged steel, equipped with 2-Carbide  
Wheels, with spring, Carded

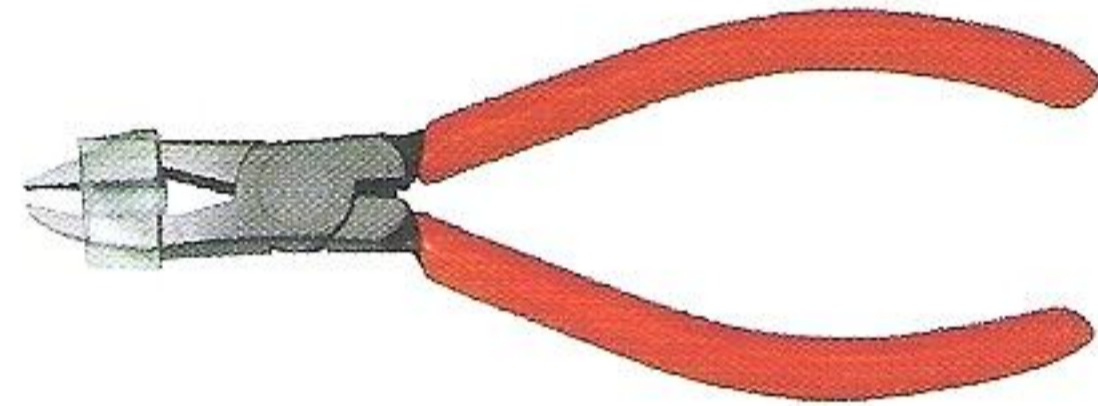

Nr. 705 2150

**6" Mini Grozer**

Drop forged steel, hardened  
With PVC coated grip, Carded.

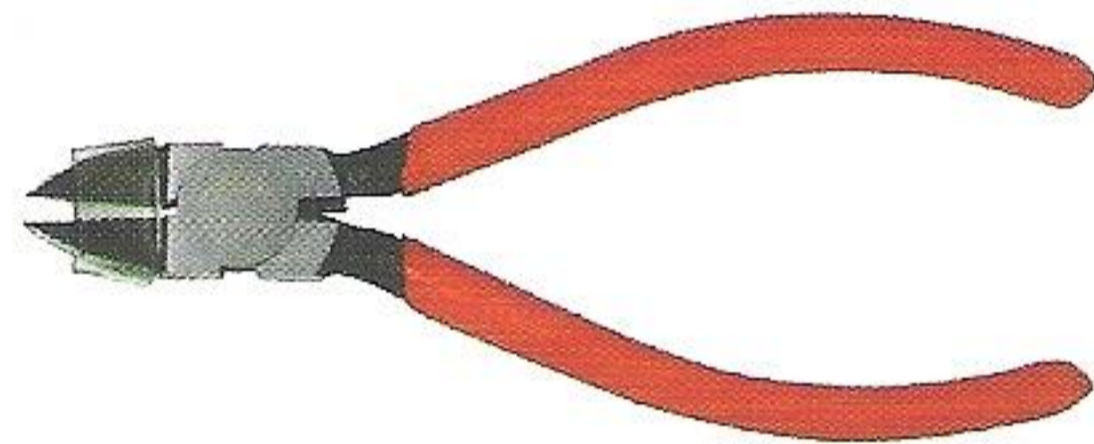

Nr. 705 3150

**6" Lead Cutting Plier**

Drop forged steel, hardened  
With PVC coated grip, Carded.

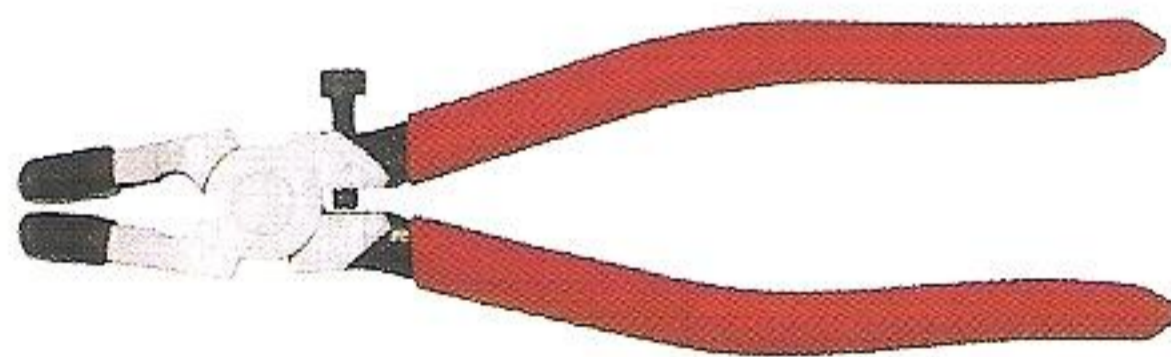

Nr. 705 4200

**8" Glass Breaking Plier**

Drop forged steel, hardened,  
With screw and PVC coated grip, Carded.

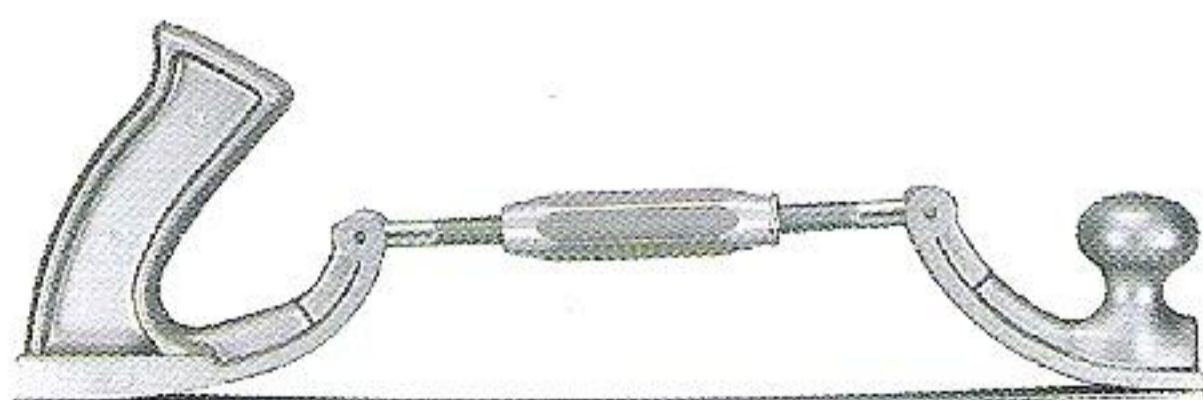

Nr. 703 2010

**Curved File Holder**

For 14" (350mm) Flexible File  
Adjustable Frame, Each boxed

Nr. 702 3001

**Inside & Outside Deburrer**

Metal body, with 3 cutting blade,  
Red painted, for size of  $\phi$  3 ~ 40mm, Boxed



Nr. 702 3012

**Tubing Cutter,**

Silver grey painted,  
Aluminium die cast frame,  
For soft metal tubes, Packed in card,  
Cutting capacity:  $\phi$  3 ~ 38mm

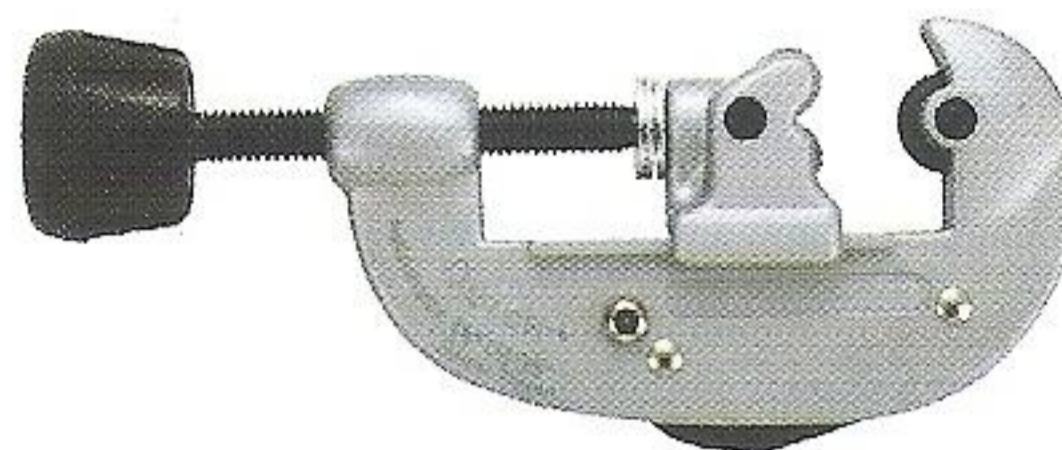

Nr. 702 3024

**Telescopic Tubing Cutter**

Metal body with cutting wheel,  
For size of  $\phi$  6 ~ 38mm, Carded



Nr. 702 3076

**Telescopic Pipe Cutter**

Aluminum cast frame with telescopic function,  
Suitable for copper,  
For size of  $\phi$  6 ~ 76mm, White boxed.



Nr. 702 3140

**Telescopic Pipe Cutter**

Aluminum cast frame with telescopic function,  
Suitable for copper,  
For size of  $\phi$  50 ~ 140mm, White boxed.



**Tube Bender**

Bends up to 180°  
Idea for copper, brass, aluminum & soft tubes  
Bulk, Polybaged

- Nr. 702 1008            8mm
- Nr. 702 1010           10mm
- Nr. 702 1012           12mm
- Nr. 702 1014           14mm

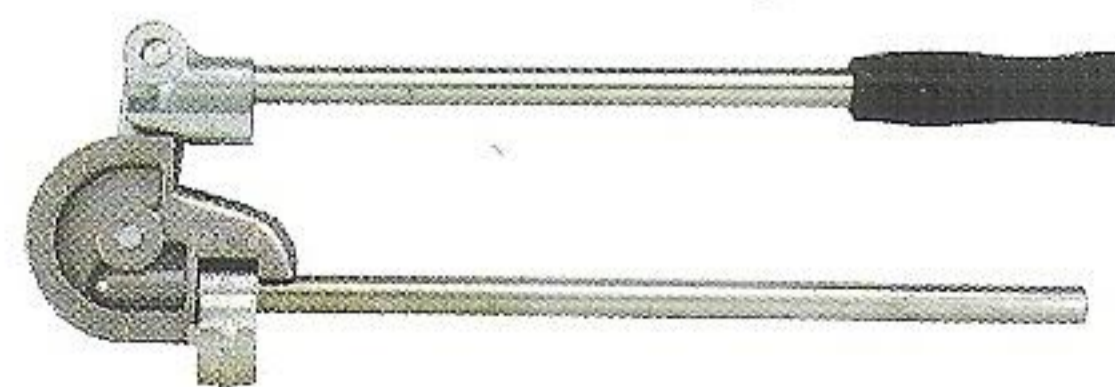



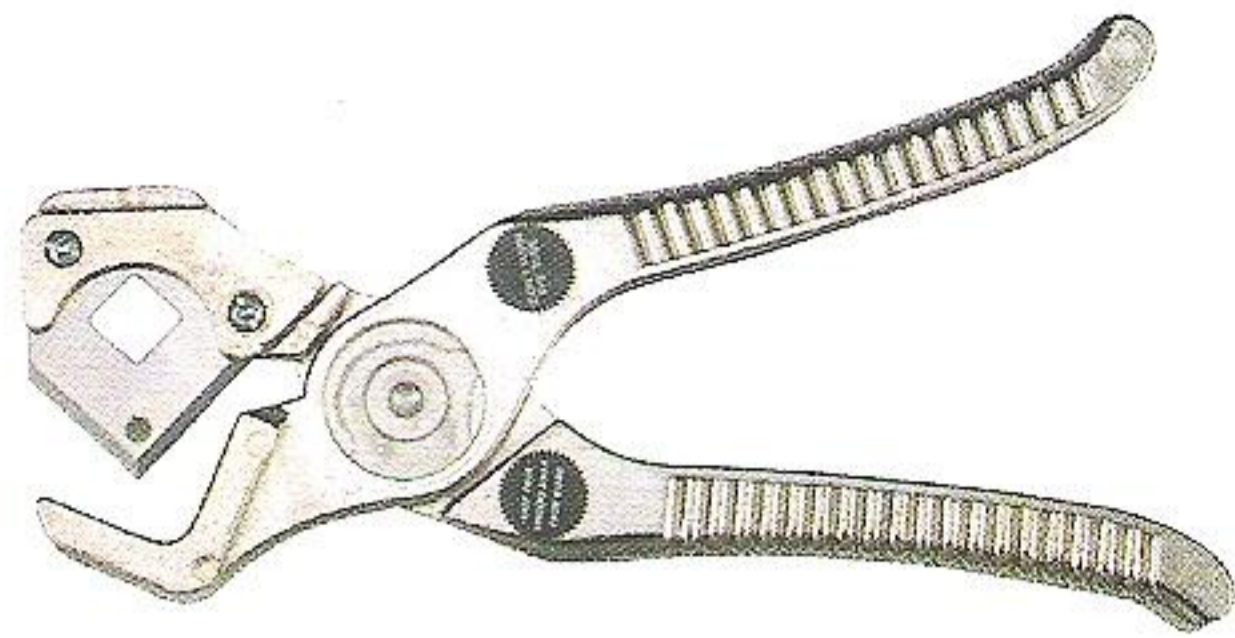

Nr. 702 7001

**Hose Cutter**

Metal body, special cutting knife,  
For thin-wal Plastic pieces, Polybaged  
Cutting capacity:  $\phi$  6 - 25mm



Nr. 702 7003

**PVC Pipe Cutter**

Aluminum alloy body, red painted  
With two stop adjuetment, Boxed  
Capacity:  $\phi$  6 ~ 35mm

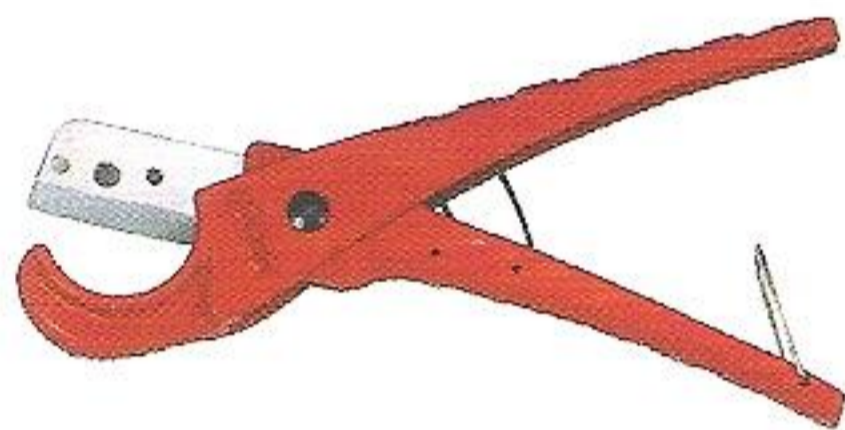

Nr. 702 9101

**Soft Pipe Cutter**

Alumimun alloy body with SK5 steel black blade,  
Design for soft pipes cutting, Carded  
Cutting capacity:  $\phi$  6 - 37mm

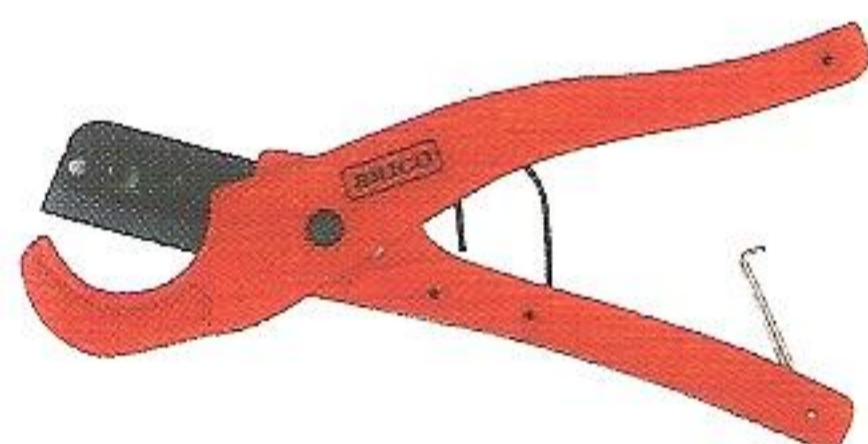

Nr. 702 9102

**Soft Pipe Cutter**

PVC Body With SK5 Steel Black Blade,  
For cutting of soft plastic pipes, Carded  
Cutting capacity:  $\phi$  6 - 37mm

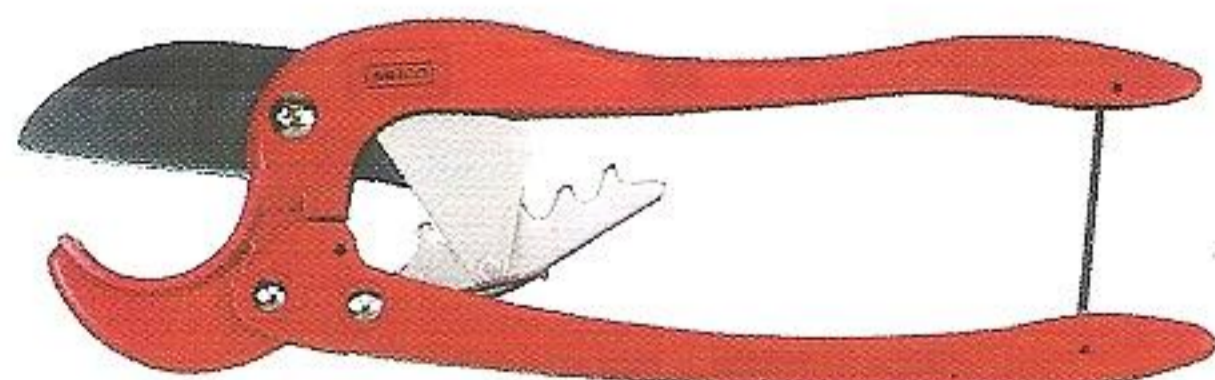

Nr. 702 9103

**Plastic Pipe Cutter**

Aluminium alloy body with SK5 special steel blade,  
Ideal for cutting of PE, PP & PVDF pipes, Boxed  
Cutting capacity:  $\phi$  25 - 63mm

**Nr. 648 0080**

**9-pcs Hole Punch Set**

Drop Forged steel, Black finish shank  
Packed in round plastic case, color boxed.

Consisting of:  $\phi$  2.5 - 3 - 4 - 5 - 6 - 7  
 $\phi$  8 - 9 - 10mm



**Nr. 648 0659**

**6-pcs Pin Punch Set**

Chrome Vanadium steel, Hardened,  
Painted shank, Packed in pouch.

Consisting of:  $\phi$  3 - 4 - 5 - 6 - 7 - 8mm



**Nr. 648 0660**

**6-pcs Pin Punch Set**

Chrome Vanadium steel, Hardened,  
Fully mirror polished, Chrome plated,  
Packed in plastic holder.

Consisting of:  $\phi$  2mm x 8mm x 115mm  
 $\phi$  3mm x 8mm x 125mm  
 $\phi$  4mm x 9.5mm x 150mm  
 $\phi$  5mm x 9.5mm x 165mm  
 $\phi$  6mm x 12.7mm x 180mm  
 $\phi$  8mm x 12.7mm x 180mm



**Nr. 648 0650**

**5-pcs Punch & Chisel Set**

Chrome Vanadium steel, Hardened  
Fully mirror polished, Chrome plated,  
Packed in plastic holder.

Consisting of:  
Pin Punch  $\phi$  4mm x 9.5mm x 150mm  
Taper Punch  $\phi$  3mm x 9.5mm x 120mm  
Center Punch No.2 x 9.5mm x 120mm  
Cape Chisel 5mm x 9.5mm x 130mm  
Cold Chisel 12mm x 9.5mm x 130mm



**Nr. 648 1170**

**17-pcs Pin Punch & Taper Punch Set**

Chrome Vanadium steel, Hardened  
Fully mirror polished, Chrome plated,  
Packed in metal rack and boxed.

Consisting of:  
5 x Taper Punches 2 - 3 - 4 - 5 - 6mm  
6 x Pin Punches 2 - 3 - 4 - 5 - 6 - 8mm  
6 x Long Pin Punches 3 - 4 - 5 - 6 - 8 - 10mm



Nr. 789 1014K

**14-pcs Universal Radiator Pressure Tester Kit**

Packed in BMC.

- 0 : Temperature needle
- 1 : Pressure Testing Pump With Gauge NO.2~3are Test Adapters
- 2 : Large Truck, GM(CADILLAC)
- 3 : BENZ \ FORD \ Large Truck \ Vehicle123series \ GM(BUICK) \ JEEP
- 4 : PEUGEOT \ Vehicle124series(MITSUBISHI \ NISSAN \ MAZDA \ TOYOTA \ SUBARU \ INFINITI \ GEO \ SUZUKI \ ISUZU \ MITSUBISHI)
- 5 : Vehicle125series(HONDA \ TOYOTA \ SUZUKI \ MITSUBISHI)
- 6 : OPEL \ VW \ FORD \ BMW245 \ SAAB \ JAGUAR
- 7 : VOLVO \ SAAB \ AUDI \ CITRON \ RENAULT \ FLAT \ PEUGEOT \ ALFA \ JEEP
- 8 : NEW VW
- 9 : VW T4 \ NEW AUDI A4 \ A5 \ A6 \ BMW345
- 10: BMW
- 11: AUDI \ VW
- 12: FORD \ INTERANTIONAL \ GM \ ROVER
- 13: BENZ

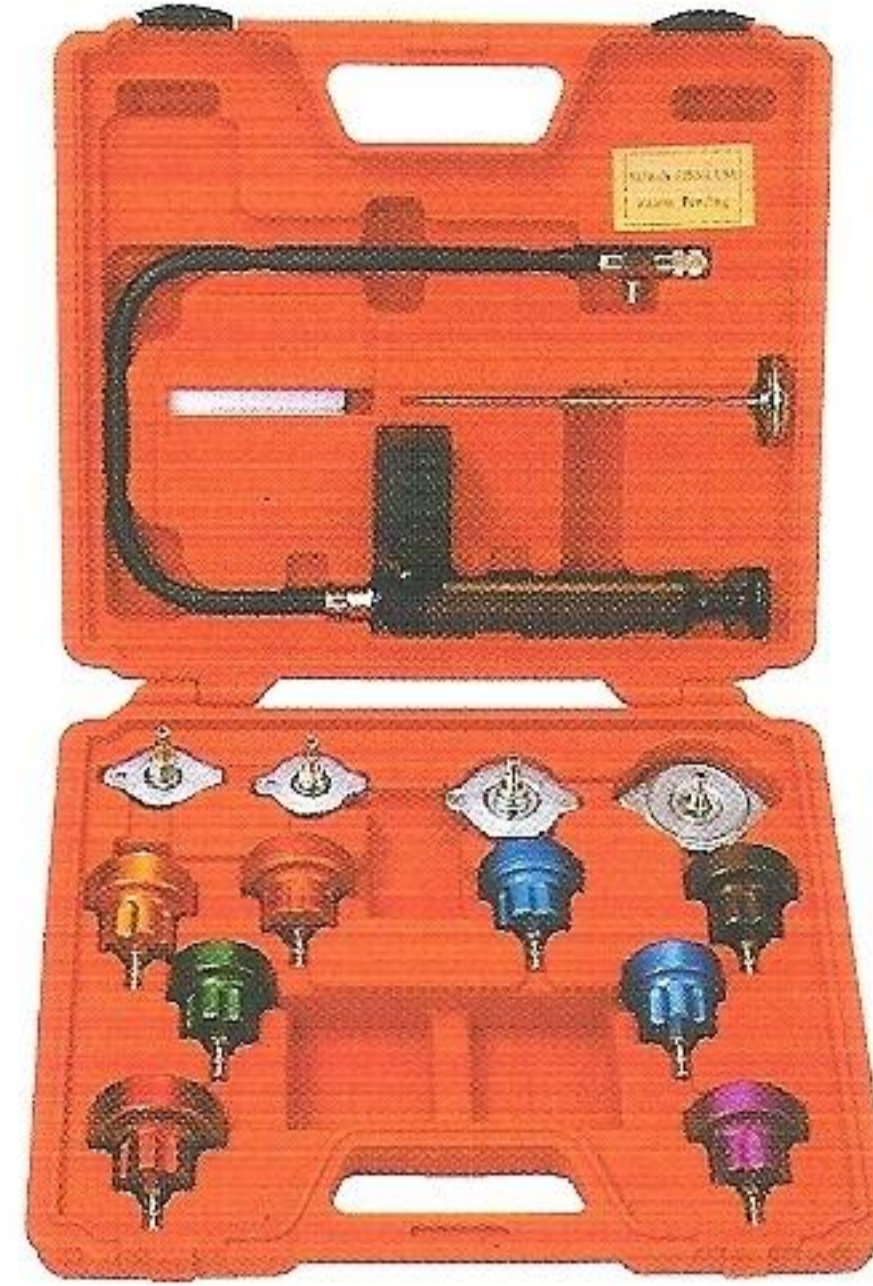

Nr. 789 1008

**8-pcs Axle Spindle Rethreading Set**

Containing 8-pcs Thread dies for using on the spindles

Of the following sizes, Packed in BMC

- |           |                  |
|-----------|------------------|
| M24 x 1.5 | M20 x 1.5        |
| M24 x 2.0 | M20 x 1.25       |
| M22 x 1.0 | 13/16" x 20 UNEF |
| M22 x 1.5 | 3/4" x 20 UNEF   |

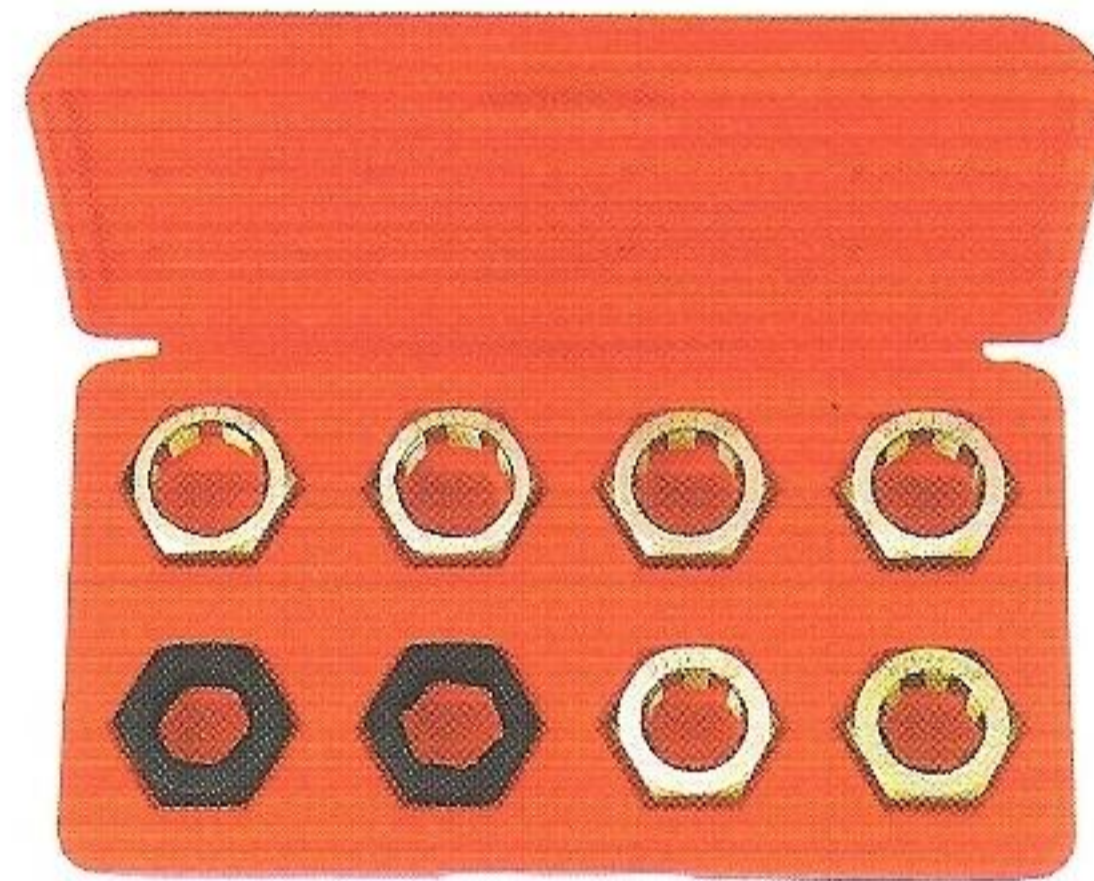

**Striking Face Type Box Wrenches**

Chrome-Molybdenum steel, Black phosphated finish, Packed in Box.

- |              |              |
|--------------|--------------|
| Nr. 616 5022 | 22mm x 165mm |
| Nr. 616 5024 | 24mm x 165mm |
| Nr. 616 5027 | 27mm x 190mm |
| Nr. 616 5030 | 30mm x 190mm |
| Nr. 616 5032 | 32mm x 200mm |
| Nr. 616 5034 | 34mm x 200mm |
| Nr. 616 5035 | 35mm x 200mm |
| Nr. 616 5036 | 36mm x 210mm |
| Nr. 616 5038 | 38mm x 210mm |
| Nr. 616 5041 | 41mm x 230mm |
| Nr. 616 5046 | 46mm x 250mm |
| Nr. 616 5050 | 50mm x 250mm |
| Nr. 616 5054 | 54mm x 270mm |
| Nr. 616 5055 | 55mm x 270mm |
| Nr. 616 5058 | 58mm x 270mm |
| Nr. 616 5060 | 60mm x 290mm |
| Nr. 616 5063 | 63mm x 290mm |
| Nr. 616 5065 | 65mm x 290mm |

